

Data sheet

Part No. **CB 3 WH**

Description distribution box

Circular box for surface installation with 2 mounting lugs, standard mounting screw spacing 50.8mm (2") for conduit diameters 20mm to 25mm, with brass inserts M 4, without lid

Colour white, similar to RAL 9010

PVC-LSF 



Standard: BS 4607, EN 60670



Working temperature	Degree of protection (IP)	Number of inlets	Material
-5 to +60 °C	IP3X	3	PVC-LSF

Art. no.	Dimensions Ø/LxW x D	For tube diameter	ps	pl
104 244 CB 20/3 WH	65 x 32 mm	20 mm	25 pc	240 pc
104 249 CB 25/3 WH	65 x 32 mm	25 mm	20 pc	200 pc

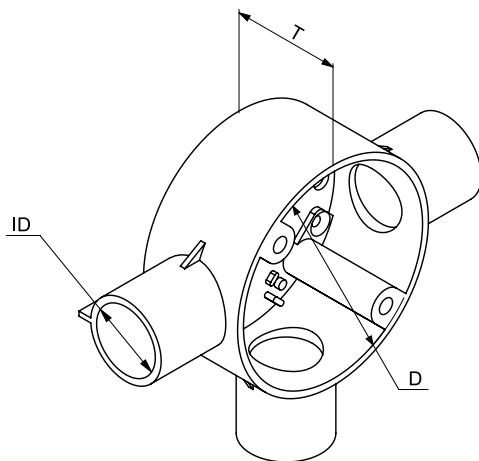

For sale in the UK market only.