

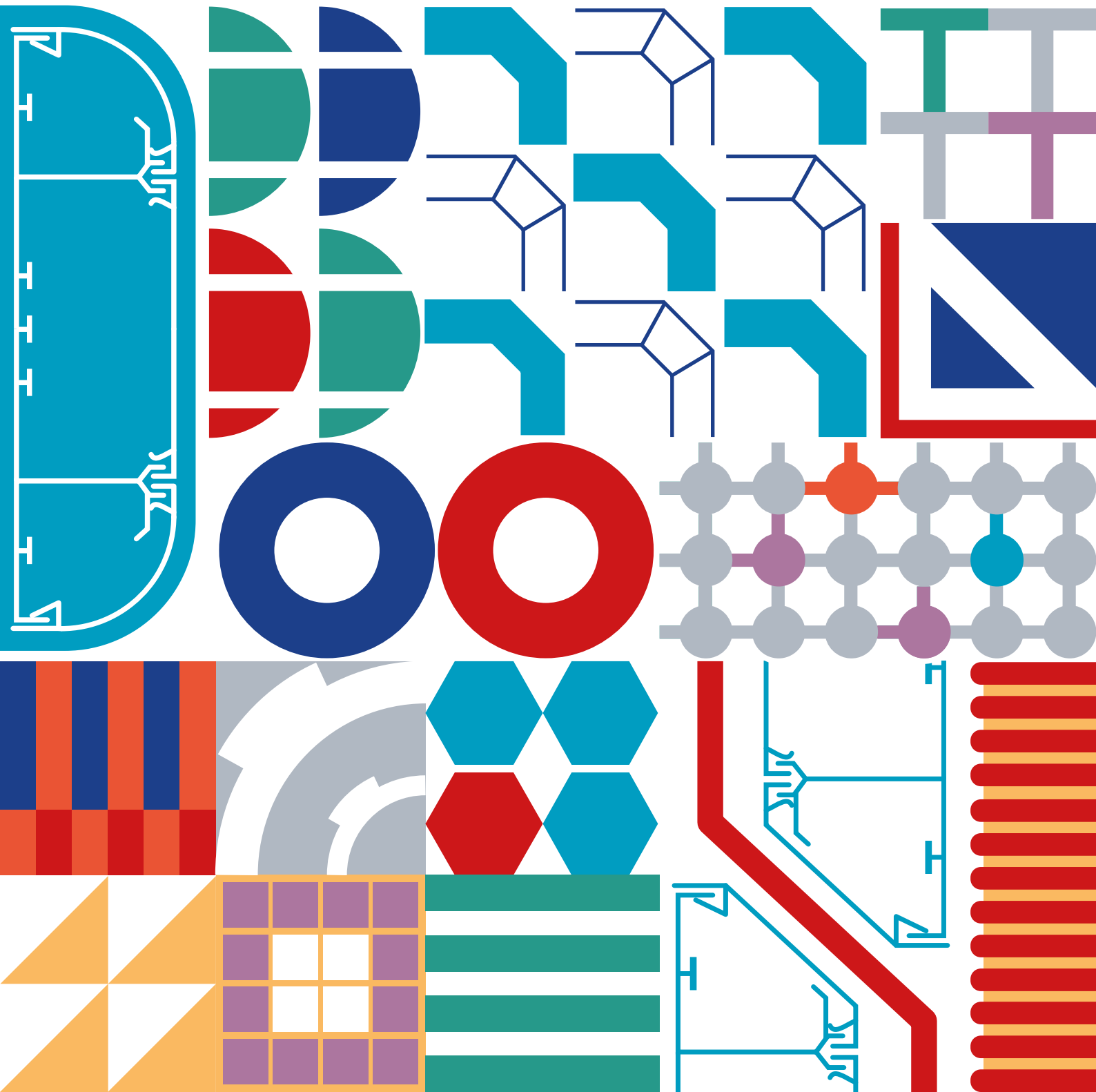

**DIETZEL**  
**UNIVOLT**  
full of **energy.**

# Product CATALOGUE v2





## About Us

Univolt is a leading global cable management manufacturer, whose presence in the UK spans some two decades, and whose foundations lie in Austria, where the business was formed in 1938.

A family owned enterprise, Univolt remains in the hands of the original family, on whose values, ethos and vision the business continues to thrive.

Today, Univolt in the UK is a market leading force within the industry, strengthening and consolidating its position across expansive networks, and diverse market sectors. The brand is synonymous with quality, owning an extensive product range, delivering unrivalled customer service, with innovation at the very heart of the operation.

### Univolt in the UK

Univolt's UK headquarters are set in a 25,000 sq ft state of the art warehouse and office facility in Hertfordshire. With vast storage space, Univolt is able to hold industry leading stock levels.

Customers are supported by an established and highly experienced team, providing back office advice and guidance, as well as a strong national sales team, guaranteeing full UK coverage.



## CONTENTS

<b>A Brief Guide To Plastic Conduit and Fire Safety</b>	<b>7</b>
<b>HFT - Next Generation Conduit</b>	<b>10</b>
<b>Rigid Conduit &amp; Accessories</b>	<b>20</b>
<b>Mini Trunking / Oval Conduit / Channel</b>	<b>26</b>
<b>Surface Boxes</b>	<b>30</b>
<b>New Red / Black surface boxes</b>	<b>31</b>
<b>Maxi Trunking</b>	<b>34</b>
<b>Starline Trunking SLR</b>	<b>38</b>
<b>Starline Trunking SLXL</b>	<b>40</b>
<b>Starline Trunking SLC</b>	<b>42</b>
<b>Starline Trunking SLSR</b>	<b>44</b>
<b>Starline Trunking SLQN</b>	<b>46</b>
<b>PVC Bench Trunking</b>	<b>48</b>
<b>Aluminium Power Pole &amp; Bespoke Power Pole</b>	<b>50</b>
<b>Floor Boxes &amp; Plates</b>	<b>56</b>
<b>Thermoplastic Cable Tray</b>	<b>60</b>
<b>FlexX Steel</b>	<b>66</b>
<b>Flexible Conduit PVC-U / Flexible Conduit Contractor Packs</b>	<b>70</b>
<b>Twin Wall Ducting</b>	<b>74</b>
<b>Enclosure Boxes / Accessories</b>	<b>76</b>



## Our Goals

The Univolt philosophy is centred upon building long-term partnerships with customers.

Company values are based on integrity, honesty and fairness, maintaining high ethical standards across the entire operation.

Univolt strive to be trailblazing, innovative and enterprising, as the evolution of the range continues.

The business consider success in the past as an important source for future development, with one clear goal in mind - always to be one step ahead.

## Manufacturing and product development

Operating several global manufacturing sites, Univolt continues to refine, innovate and build on its core product range.

The business is able to utilise the skills of a dynamic international team who use the most advanced technologies and processes to produce quality, durable and aesthetically pleasing products in volume.

Creating the next generation of cable management products and accessories, the Univolt range blends with merging trends and regulations, adapting to modern methods of technology and construction.



## Partnerships (buying groups and national wholesalers)

Partnerships and a collaborative working approach sit at the heart of the Univolt operation. The business is committed to the relationships it has, and continues to build, with the electrical wholesaler market, who are a direct route to the end user.

Univolt is a committed supplier to the independent and national wholesaler markets, and is also a preferred supplier to all UK buying groups, recognising the importance of these networks and partnerships in fostering sound relationships, supporting and sharing best practise.

## SUSTAINABILITY AND THE ENVIRONMENT



As a family-owned global enterprise, Univolt is aware of its responsibility to safeguard future generations and to protect the wider environment, as the company continually scrutinise every aspect of its operation.

### Packaging, recycling and waste prevention

At the Univolt Austrian plant, the company purchased 10 packaging machines, realising a saving of 91,000kg of packaging film per year since 2019. Packaging that cannot be saved is collected via ARA in Austria and in 2022, Univolt saved 82 tonnes of CO<sub>2</sub> using this system.

Since 2024, packaging film with a thinner wall thickness has been used for rigid conduits, saving 11,400kg of packaging material per year - the equivalent of almost 23 tonnes of CO<sub>2</sub>. In addition, the logo print has been reduced so that less printing ink needs to be used and recycling is simplified.

**All cardboard packaging is made from 100% recycled paper.**



### Participant of the UN Global Compact

Univolt is a registered participant of the United Nations Global Compact and adheres to a corporate mission which encompasses the ten UN Global Compact principles.

Univolt believe that professional excellence and striving for the highest levels of customer satisfaction, meeting all relevant quality standards, developing strong business partnerships and the continued development of employees, are intrinsically tied to a corporate code of ethics. Within the businesses scope of influence Univolt follow and uphold the following - The Universal Declaration of Human Rights, The International Labour Organization's Declaration on Fundamental Principles and Rights at Work, The Rio Declaration on Environment and Development, and The United Nations Convention Against Corruption.



## SUSTAINABILITY AND THE ENVIRONMENT *continued*

### Corporate Carbon Footprint (CCF)

The path to climate neutrality begins with the collection of emissions generated through the company. In a first step, Univolt calculated CCF (Scope 1 and 2 according to GHG) in 2021 at company sites in Vienna and Pezinok. Compared to the average emissions in Austria and Slovakia, 996.9 t CO<sub>2</sub> was saved this year.



### Solar power on the roof

Univolt generate a fifth of all electricity requirements via a photovoltaic system on the roof of the Vienna site. During weekends - when there is no production - all of the electricity is fed back into the grid.

### ISO Certifications

Univolt has secured and maintained the following ISO certification - ISO 9001, ISO 14001 and an EcoVadis score of 66.

### Product development

LSF0H/HFT products are antimony free, fully complying with REACH regulations and do not contain any forbidden substances listed in RoHS.

LSF0H conduits are chlorine free, halogen-free, flame retardant, temperature resistant and 100% recyclable.



## A BRIEF GUIDE TO CONDUIT AND FIRE SAFETY

### Leaders in safety specification

Safety will always remain the overarching priority when approaching any electrical installation, and product specification is inevitably a key element within this process. This brief guide provides an overview of the product properties within the various Univolt conduits ...

### What is PVC LSF? (smoke release ISO5659-2:2012)

A significant improvement over standard PVC products, PVC LSF (Lower Smoke Fume) conduit offers increased flame retardancy and reduced smoke output compared to standard PVC conduit.

PVC LSF also offers lower smoke emissions than standard PVC:

- Reduces smoke release by up to 65% in the first 4 minutes of a fire
- Lower smoke - Increased flame retardancy
- Takes up to 15% longer to ignite

### Smoke Release - Standard PVC vs PVC/LSF\*

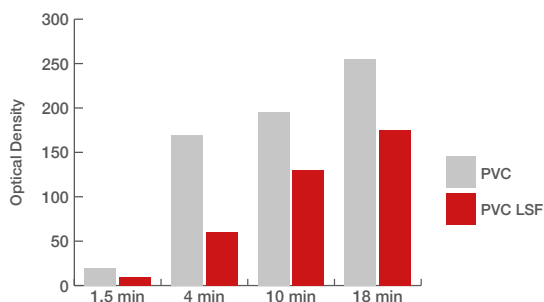

\* All figures refer to standardised test samples and are given to our best knowledge but without further commitment. It is Univolt's belief that information set forth in this Data Sheet is accurate, Univolt makes no warranty, expressed or implied, with respect thereto and disclaims any liability from reliance thereon. All data are subject to change without prior notice.



## A BRIEF GUIDE TO CONDUIT AND FIRE SAFETY *continued*

### HFT (LSFOH) - Next Generation Conduit

Univolt is recognised globally for its commitment to safety driven cable management solutions. The company continues to push boundaries across its product range and notably through its HFT specification.

Polypropylene is a viable alternative to PVC and is used to produce HFT installation systems. These products are 100% free from toxic halogens and therefore, offer a number of considerable advantages over conventional systems including:

- No formation of corrosive and acidic gases
- Decisively reduced toxicity and no aggressive fumes
- Reduced smoke density
- High impact resistance
- High temperature resistance



#### What is an LSFOH conduit?

The ultimate safety-first driven specification, LSFOH (Low Smoke Fume Zero Halogen) conduits contain less than 0.5% halogens and minimal smoke generation. This product is ideal for public buildings, business environments, airports, railways, data centres, tunnels and all escape routes.

LSFOH conduits do not emit toxic gases and maintain visibility even in restricted spaces. They also ensure the continued operation of electrical devices that may be susceptible to damage from corrosive gases and fumes. Moreover, this specification is flame retardant and self-extinguishing, which reduces the spread of flames to a larger area.

#### Setting the Standards

- IEC 63355
- Zero Halogen to IEC 60754-1/60754-2
- Flame retardant to IEC 61386
- Low smoke according to IEC 60134

## A BRIEF GUIDE TO CONDUIT AND FIRE SAFETY *continued*

### HFT Product Range

#### Rigid and pliable conduits

Our range of HFT material covers rigid and pliable conduits for versatile use as insulating protection for concealed cabling or surface installations.

The installation of these conduits is especially recommended in buildings with high concentrations of people or assets, such as residential buildings, offices, hospitals, schools and hotels.



### Univolt HFT ( LSFOH ) Cable Management Systems Understanding the standards

The introduction of the BS EN IEC63355 standard in 2023 represents the benchmark upon which all cable management products must adhere to, reflecting the most recent industry advancements and research.

#### Why BS EN IEC 63355?

The presence of halogens in cable management systems can lead to potential hazards, including the release of toxic gases when exposed to high temperatures. **BS EN IEC 63355** provides a systematic and reliable method for testing halogen content, ensuring the safety and integrity of any cable management system.

By adhering to this standard, specifiers can ensure compliance with safety regulations, avoid potential legal issues, and provide a safer environment for employees and customers. It's not just about safety, but also about the longevity and performance of your cable management system.

**BS EN IEC 63355** is more than just a standard - it's a commitment to safety, quality, and excellence. Adhering to this standard promotes a safety first culture, also contributing to the overall advancement of the industry.





# HFT - Next Generation (LSF0H, Chlorine Free)



The ultimate safety-first driven specification, LSF0H (Low Smoke Fume Zero Halogen) conduits contain less than 0.5% halogens and minimal smoke generation. This product is ideal for public buildings, business environments, airports, railways, data centres, tunnels and all escape routes.

LSF0H conduits do not emit toxic gases and maintain visibility even in restricted spaces. They also ensure the continued operation of electrical devices that may be susceptible to damage from corrosive gases and fumes. Moreover, this specification is flame retardant and self-extinguishing, which reduces the spread of flames to a larger area.

### Setting the Standards

- IEC 63355
- Low Smoke according to IEC 60134
- Zero Halogen to IEC 60754-1/60754-2
- Flame retardant to IEC 61386

Univolt's HFT LSF0H rigid conduits are **NOT** suitable to be used with bending springs. Please use Univolt's extensive range of accessories to suit. Univolt recommend PERMAPOND TA4610 (or similar). This is a special adhesive for HFT LSF0H conduits.

## Rigid Conduit Light LSF0H EN-61386-21



Part No.	A-Code	Description	Pk Qty
HFIR 20 White	87179	Rigid conduit, 20mm, light gauge	90m
HFIR 25 White	87180	Rigid conduit, 25mm, light gauge	90m
HFIR 32 White	87181	Rigid conduit, 32mm, light gauge	30m
HFIRM 20 Light Grey	87216	Rigid conduit, 20mm, light gauge, moulded coupler	90m
HFIRM 25 Light Grey	87217	Rigid conduit, 25mm, light gauge, moulded coupler	90m
HFIRM 32 Light Grey	87218	Rigid Conduit 32mm, light gauge, moulded coupler	30m

## Rigid Conduit Medium LSF0H EN-61386-21



Part No.	A-Code	Description	Pk Qty
HFPRM 20 Black	87220	Rigid conduit, 20mm, medium gauge, moulded coupler	90m
HFPRM 25 Black	87221	Rigid conduit, 25mm, medium gauge, moulded coupler	90m
HFPRM 32 Black	87222	Rigid conduit, 32mm, medium gauge, moulded coupler	30m
HFPRM 20 Light Grey	87224	Rigid conduit, 20mm, medium gauge, moulded coupler	90m
HFPRM 25 Light Grey	87225	Rigid conduit, 25mm, medium gauge, moulded coupler	90m
HFPRM 32 Light Grey	87226	Rigid conduit, 32mm, medium gauge, moulded coupler	30m

## Rigid Conduit Heavy LSF0H EN-61386-21

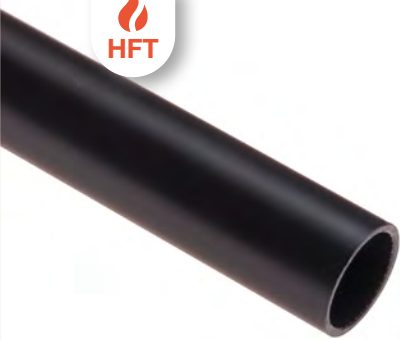

Part No.	A-Code	Description	Pk Qty
HFBS 20 Black	99871	Rigid conduit, 20mm, heavy gauge	90m
HFBS 25 Black	99872	Rigid conduit, 25mm, heavy gauge	90m
HFBS 32 Black	99873	Rigid conduit, 32mm, heavy gauge	30m

## Fittings - Halogen Free

Saddles



Part No.	A-Code	Description	Pk Qty
HFS 20 White	41832	Saddle, 20mm, White	50pcs
HFS 25 White	41833	Saddle, 25mm, White	100pcs
HFS 32 White	41834	Saddle, 32mm, White	100pcs
HFS 20 Grey	80812	Saddle, 20mm, Light Grey	50pcs
HFS 25 Grey	80813	Saddle, 25mm, Light Grey	100pcs
HFS 32 Grey	80814	Saddle, 32mm, Light Grey	100pcs
HFS 20 Black	20833	Saddle, 20mm, Black	50pcs
HFS 25 Black	20834	Saddle, 25mm, Black	100pcs
HFS 32 Black	20835	Saddle, 32mm, Black	100pcs

Spacer Bar Saddles



Part No.	A-Code	Description	Pk Qty
HFSBS 20 White	37033	Spacer bar saddle, 20mm, White	50pcs
HFSBS 25 White	41621	Spacer bar saddle, 25mm, White	50pcs
HFSBS 32 White	41853	Spacer bar saddle, 32mm, White	50pcs
HFSBS 20 Black	9629	Spacer bar saddle, 20mm, Black	50pcs
HFSBS 25 Black	9630	Spacer bar saddle, 25mm, Black	50pcs
HFSBS 32 Black	9631	Spacer bar saddle, 32mm, Black	50pcs

Slip Type Couplers



Part No.	A-Code	Description	Pk Qty
HFSM 20 White	37036	Coupler, 20mm, White	100pcs
HFSM 25 White	38572	Coupler, 25mm, White	50pcs
HFSM 32 White	38573	Coupler, 32mm, White	25pcs
HFSM 20 Black	20557	Coupler, 20mm, Black	100pcs
HFSM 25 Black	20558	Coupler, 25mm, Black	50pcs
HFSM 32 Black	20559	Coupler, 32mm, Black	25pcs
HFSM 20 Grey	41017	Coupler, 20mm, Light Grey	100pcs
HFSM 25 Grey	41422	Coupler, 25mm, Light Grey	50pcs
HFSM 32 Grey	41423	Coupler, 32mm, Light Grey	25pcs



## Fittings - Halogen Free

			<b>Part No.</b>	<b>A-Code</b>	<b>Description</b>	<b>Pk Qty</b>
Reducer Coupler			HFUM 20/25 SW	26402	Reducer coupler 25mm to 20mm, Black	100pcs
Normal Bend			<b>Part No.</b>	<b>A-Code</b>	<b>Description</b>	<b>Pk Qty</b>
			HFSB 20 White	106173	Normal bend, 20mm, 90°, with coupler, White	25pcs
			HFSB 25 White	106174	Normal bend, 25mm, 90°, with coupler, White	20pcs
			HFSB 32 White	106175	Normal bend, 32mm, 90°, with coupler, White	15pcs
			HFSB 20 Black	106166	Normal bend, 20mm, 90°, with coupler, Black	25pcs
			HFSB 25 Black	106167	Normal bend, 25mm, 90°, with coupler, Black	20pcs
			HFSB 32 Black	106168	Normal bend, 32mm, 90°, with coupler, Black	15pcs
			HFSB 20 Grey	106159	Normal bend, 20mm, 90°, with coupler, Light Grey	25pcs
			HFSB 25 Grey	106160	Normal bend, 25mm, 90°, with coupler, Light Grey	25pcs
			HFSB 32 Grey	106161	Normal bend, 32mm, 90°, with coupler, Light Grey	15pcs
Inspection Bend			<b>Part No.</b>	<b>A-Code</b>	<b>Description</b>	<b>Pk Qty</b>
			HFIB 20 White	37127	Inspection bend, 20mm, White	50pcs
			HFIB 25 White	86344	Inspection bend, 25mm, White	20pcs
			HFIB 20 Black	9643	Inspection bend, 20mm, Black	50pcs
			HFIB 25 Black	9644	Inspection bend, 25mm, Black	20pcs
Inspection Tee			<b>Part No.</b>	<b>A-Code</b>	<b>Description</b>	<b>Pk Qty</b>
			HFIT 20 White	37133	Inspection tee, 20mm, White	50pcs
			HFIT 25 White	41468	Inspection tee, 25mm, White	20pcs
			HFIT 20 Black	9640	Inspection tee, 20mm, Black	50pcs
			HFIT 25 Black	9641	Inspection tee, 25mm, Black	20pcs
			HFIT 32 Black	104456	Inspection tee, 32mm, Black	10pcs
			HFIT 20 Grey	82561	Inspection tee, 20mm, Light Grey	50pcs
			HFIT 25 Grey	82562	Inspection tee, 25mm, Light Grey	20pcs
			HFIT 32 Grey	106437	Inspection tee, 32mm, Light Grey	10pcs
Inspection Elbow			<b>Part No.</b>	<b>A-Code</b>	<b>Description</b>	<b>Pk Qty</b>
			HFIE 20 Black	26968	Inspection elbow, 20mm, Black	50pcs
			HFIE 25 Black	26969	Inspection elbow, 25mm, Black	20pcs
			HFIE 32 Black	104457	Inspection elbow, 32mm, Black	25pcs

Female Adaptors



Part No.	A-Code	Description	Pk Qty
HFAFT/MBS 20 White	37043	Female Adaptor, 20mm, White	100pcs
HFAFT/MBS 25 White	41465	Female Adaptor, 25mm, White	50pcs
HFAFT/MBS 32 White	64271	Female Adaptor, 32mm, White	20pcs
HFAFT/MBS 20 Black	9674	Female Adaptor, 20mm, Black	100pcs
HFAFT/MBS 25 Black	9675	Female Adaptor, 25mm, Black	50pcs
HFAFT/MBS 32 Black	9676	Female Adaptor, 32mm, Black	20pcs
HFAFT/MBS 20 Grey	81032	Female Adaptor, 20mm, Light Grey	100pcs
HFAFT/MBS 25 Grey	81033	Female Adaptor, 25mm, Light Grey	50pcs
HFAFT/MBS 32 Grey	84575	Female Adaptor, 32mm, Light Grey	20pcs

Male Adaptors



Part No.	A-Code	Description	Pk Qty
HFAMT/LR 20 White	40363	Male Adaptor 20mm c/w locking, White	100pcs
HFAMT/LR 20 Black	9680	Male Adaptor 20mm c/w locking, Black	100pcs
HFAMT/LR 25 Black	9681	Male Adaptor 25mm c/w locking, Black	50pcs
HFAMT/LN 20 Black	20843	Male Adaptor 20mm c/w locknut, Black	100pcs
HFAMT/LN 25 Black	20844	Male Adaptor 25mm c/w locknut, Black	50pcs

Clips



Part No.	A-Code	Description	Pk Qty
HFCL 20 White	37041	Clip, 20mm, Interlinkable, White	100pcs
HFCL 25 White	38597	Clip, 25mm, Interlinkable, White	100pcs
HFCL 32 White	38598	Clip, 32mm, Interlinkable, White	100pcs
HFCL 20 Black	9635	Clip, 20mm, Interlinkable, Black	100pcs
HFCL 25 Black	9636	Clip, 25mm, Interlinkable, Black	100pcs
HFCL 32 Black	9637	Clip, 32mm, Interlinkable, Black	100pcs
HFCL 20 Grey	41016	Clip, 20mm, Interlinkable, Light Grey	100pcs
HFCL 25 Grey	41429	Clip, 25mm, Interlinkable, Light Grey	100pcs
HFCL 32 Grey	41430	Clip, 32mm, Interlinkable, Light Grey	100pcs



**Safety First: Univolt HFT**



## Fittings - Halogen Free *continued*

			<b>Part No.</b>	<b>A-Code</b>	<b>Description</b>	<b>Pk Qty</b>
Straight Gland			HGL 20/20 Black	11790	Straight gland 20mm, M20x1.5mm, IP54, Black	50pcs
			HGL 25/25 Black	12609	Straight gland 25mm, M25x1.5mm, IP54, Black	50pcs
			HGL 32/32 Black	12754	Straight gland 32mm, M32x1.5mm, IP54, Black	30pcs
Elbow Glands			HEG 2020 Black	12756	Elbow gland, M20x1.5mm, IP54, Black	20pcs
			HEG 2525 Black	12757	Elbow gland, M25x1.5mm, IP54, Black	10pcs
			HEG 3232 Black	12758	Elbow gland, M32x1.5mm, IP54, Black	10pcs
Glands with Flange			HFL 20 Black	20230	Gland with flange 20mm, Black	50pcs
			HFL 25 Black	16522	Gland with flange 25mm, Black	25pcs
			HFL 32 Black	16523	Gland with flange 32mm, Black	20pcs
Locknuts			HLN 20 Black	11918	Locknut, 20mm, Black	200pcs
			HLN 25 Black	11919	Locknut, 25mm, Black	100pcs
			HLN 32 Black	14486	Locknut, 32mm, Black	100pcs
Rail for Clips			HSKH II/20 Grey	23759	HFT-Rail for clips, perforated, 200mm, Light Grey	50pcs
			HSKH II/20 Black	527	HFT-Rail for clips, perforated, 200mm, Black	50pcs



**LSF0H conduits have undergone rigorous investment and testing in order to produce the ultimate chlorine free, halogen-free, flame retardant, temperature resistant and 100% recyclable product. These conduits are able to tick every box in terms of sustainability.**

## Conduit Boxes - Halogen Free

			<b>Part No.</b>	<b>A-Code</b>	<b>Description</b>	<b>Pk Qty</b>
Terminal 1-way Box			HFCB 20/1 W	37038	Conduit box, terminal, 20mm, White	25pcs
			HFCB 20/1 B	9646	Conduit box, terminal, 20mm, Black	25pcs
			HFCB 25/1 W	41622	Conduit box, terminal, 25mm, White	25pcs
			HFCB 25/1 B	9647	Conduit box, terminal, 25mm, Black	25pcs
			HFCB 32/1 W	86336	Conduit box, terminal, 32mm, White	10pcs
			HFCB 32/1 B	9648	Conduit box, terminal, 32mm, Black	10pcs
Terminal 2-way Box			HFCB 20/2-U M4 B	97986	Conduit box, U, 20mm, Black	20pcs
			HFCB 25/2-U M4 B	97988	Conduit box, U, 25mm, Black	20pcs
Terminal 3-way Box			HFCB 20/3-Y M4 B	97987	Conduit box, Y, 20mm, Black	20pcs
			HFCB 25/3-Y M4 B	97989	Conduit box, Y, 25mm, Black	20pcs
Terminal 4-way Box			HFCB 20/4-H M4 B	97991	Conduit box, H, 20mm, Black	20pcs
Angle Box			HFCB 20/A W	37136	Conduit box, angle, 20mm, White	25pcs
			HFCB 20/A B	9654	Conduit box, angle, 20mm, Black	25pcs
			HFCB 25/A W	41461	Conduit box, angle, 25mm, White	25pcs
			HFCB 25/A B	9655	Conduit box, angle, 25mm, Black	25pcs
			HFCB 32/A W	86406	Conduit box, angle, 32mm, White	10pcs
			HFCB 32/A B	9656	Conduit box, angle, 32mm, Black	10pcs
Through Box			HFCB 20/2 W	37039	Conduit box, through, 20mm, White	25pcs
			HFCB 25/2 W	41459	Conduit box, through, 25mm, White	25pcs
			HFCB 32/2 W	86337	Conduit box, through, 32mm, White	10pcs
			HFCB 20/2 B	9650	Conduit box, thorough, 20mm, Black	25pcs
			HFCB 25/2 B	9651	Conduit box, through, 25mm, Black	25pcs
			HFCB 32/2 B	9652	Conduit box, through, 32mm, Black	10pcs



## Conduit Boxes - Halogen Free *continued*

					
Tee Box		<b>Part No.</b>	<b>A-Code</b>	<b>Description</b>	<b>Pk Qty</b>
		HFCB 20/3 W	37040	Conduit box, tee, 20mm, White	25pcs
		HFCB 20/3 B	9658	Conduit box, tee, 20mm, Black	25pcs
		HFCB 25/3 W	41460	Conduit box, tee, 25mm, White	20pcs
		HFCB 25/3 B	9659	Conduit box, tee, 25mm, Black	20pcs
		HFCB 32/3 W	86338	Conduit box, tee, 32mm, White	10pcs
		HFCB 32/3 B	9660	Conduit box, tee, 32mm, White	10pcs
Intersection Box		<b>Part No.</b>	<b>A-Code</b>	<b>Description</b>	<b>Pk Qty</b>
		HFCB 20/4 B	9662	Conduit box, Intersection, 20mm, Black	20pcs
		HFCB 20/4 W	37138	Conduit box, Intersection, 20mm, White	20pcs
		HFCB 25/4 B	9663	Conduit box, Intersection, 25mm, Black	10pcs
		HFCB 25/4 W	97992	Conduit box, Intersection, 25mm, Black	20pcs
		HFCB 32/4 B	9664	Conduit box, Intersection, 32mm, Black	8pcs
Circular Box Lid		<b>Part No.</b>	<b>A-Code</b>	<b>Description</b>	<b>Pk Qty</b>
		HFCBL 16-25 W	37142	Circular box lid, Ø 65mm, White	100pcs
		HFCBL 16-25 B	9665	Circular box lid, Ø 65mm, Black	100pcs
		HFCBL 32 W	86343	Circular box lid, White	100pcs
		HFCBL 32 B	9666	Circular box lid, Ø 80mm, Black	100pcs

## HFT Enclosure Boxes



<b>Part No.</b>	<b>A-Code</b>	<b>Description</b>	<b>Pk Qty</b>
PKG100 OP White	37325	Enclosure box, plain side (105x105x64mm)	5pcs
PKG200 OP White	37326	Enclosure box, plain side (200x150x85mm)	2pcs
PKG300 OP White	65716	Enclosure box, plain side (300x200x125mm)	1pc
PKG200 OP T White	42558	Enclosure box, plain side (200x150x85mm)	2pcs
PKG100 OP Grey	23760	Enclosure box, plain side (105x105x64mm)	5pcs
PKG200 OP Grey	23761	Enclosure box, plain side (200x150x85mm)	2pcs
PKG300 OP Grey	23762	Enclosure box, plain side (300x200x125mm)	1pc
PKG300 OP T Grey	33582	Enclosure box, plain side (300x200x125mm)	1pc
PKG100 OP Black	528	Enclosure box, plain side (105x105x64mm)	5pcs
PKG200 OP Black	10685	Enclosure box, plain side (200x150x85mm)	2pcs
PKG300 OP Black	13019	Enclosure box, plain side (300x200x125mm)	1pc
PKG100 OP T Black	27264	Enclosure box, plain side (105x105x64mm)	5pcs
PKG200 OP T Black	18645	Enclosure box, plain side (200x150x85mm)	2pcs
PKG300 OP T Black	13022	Enclosure box, plain side (300x200x125mm)	1pc
PKG300 OP H Black	27682	Enclosure box, plain side (300x200x125mm)	1pc

# HFT Pliable Conduits

## HFT Conduit Material Key

- PP - Polypropylene
- PC - Polycarbonate
- PA - Polyamide
- PE - Polyethylene



## HFT Pliable Conduit Light Gauge



Part No.	A-Code	Description	Pk Qty
HFX 20 White	102310	20mm, corrugated conduit, light gauge	50m
HFX 25 White	102311	25mm, corrugated conduit, light gauge	50m
HFX 32 White	102312	32mm, corrugated conduit, light gauge	25m
HFX 20 Grey	102296	20mm, corrugated conduit, light gauge	50m
HFX 25 Grey	102297	25mm, corrugated conduit, light gauge	50m
HFX 32 Grey	102298	32mm, corrugated conduit, light gauge	25m
HFX 20 Black	106057	20mm, corrugated conduit, light gauge	100m
HFX 25 Black	106058	25mm, corrugated conduit, light gauge	100m
HFX 32 Black	102305	32mm, corrugated conduit, light gauge	50m

## HFT Pliable Conduit Light Gauge (320N) - Light Grey



Part No.	A-Code	Description	Pk Qty
HFX 16 G	102295	16mm, corrugated conduit, light gauge	50m
HFX 20 G	102296	20mm, corrugated conduit, light gauge	50m
HFX 25 G	102297	25mm, corrugated conduit, light gauge	50m
HFX 32 G	102298	32mm, corrugated conduit, light gauge	25m
HFX 40 G	102299	40mm, corrugated conduit, light gauge	25m
HFX 50 G	102300	50mm, corrugated conduit, light gauge	25m
HFX 63 G	80824	63mm, corrugated conduit, light gauge	25m



## HFT Pliable Conduit Light Gauge (320N) - Black



Part No.	A-Code	Description	Pk Qty
HFX 16 BK 100M	102302	16mm, corrugated conduit, light gauge	100m
HFX 20 BK 100M	106057	20mm, corrugated conduit, light gauge	100m
HFX 25 BK 100M	106058	25mm, corrugated conduit, light gauge	100m
HFX 32 BK 50M	102305	32mm, corrugated conduit, light gauge	50m
HFX 40 BK 25M	102306	40mm, corrugated conduit, light gauge	25m
HFX 50 BK 25M	102307	50mm, corrugated conduit, light gauge	25m

## HFT Pliable Conduit Medium Gauge (750N) - Black

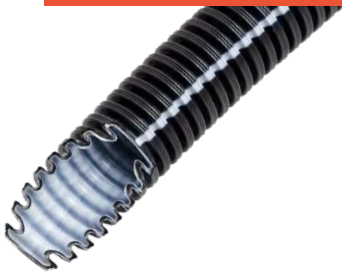

Part No.	A-Code	Description	Pk Qty
HFXP 20 Black	104830	20mm, corrugated, medium gauge	100m
HFXP 25 Black	104831	25mm, corrugated, medium gauge	100m
HFXP 32 Black	105751	32mm, corrugated, medium gauge	25m
HFXP Pro 20 Black	104838	20mm, corrugated, medium gauge	100m
HFXP Pro 25 Black	104839	25mm corrugated, medium gauge	100m
HFXP Pro 16 Black	87169	16mm, corrugated conduit, medium gauge	50m
HFXP Pro 20 Black	104836	20mm, corrugated conduit, medium gauge	50m
HFXP Pro 25 Black	104837	25mm, corrugated conduit, medium gauge	50m
HFXP Pro 32 Black	87172	32mm, corrugated conduit, medium gauge	25m
HFXP Pro 40 Black	87173	40mm, corrugated conduit, medium gauge	25m
HFXP Pro 50 Black	87174	50mm, corrugated conduit, medium gauge	25m

## HFT Pliable Conduit Medium Gauge (750N) - Black



Part No.	A-Code	Description	Pk Qty
HFXP- HT 12 B	16574	12mm, corrugated conduit, medium gauge	50m
HFXP- HT 16 B	11301	16mm, corrugated conduit, medium gauge	50m
HFXP- HT 20 B	11302	20mm, corrugated conduit, medium gauge	50m
HFXP- HT 25 B	11303	25mm, corrugated conduit, medium gauge	50m
HFXP- HT 32 B	11304	32mm, corrugated conduit, medium gauge	25m
HFXP- HT 40 B	13254	40mm, corrugated conduit, medium gauge	25m
HFXP- HT 50 B	13255	50mm, corrugated conduit, medium gauge	25m
HFXP- HT 63 B	19897	63mm, corrugated conduit, medium gauge	25m

## HFT Flexible Conduit Light Gauge (320N) - Grey



Part No.	A-Code	Description	Pk Qty
HFXS 12 G	15902	12mm, corrugated conduit, light gauge	50m
HFXS 16 G	12903	16mm, corrugated conduit, light gauge	50m
HFXS 20 G	12904	20mm, corrugated conduit, light gauge	50m
HFXS 25 G	12905	25mm, corrugated conduit, light gauge	50m
HFXS 32 G	12906	32mm, corrugated conduit, light gauge	25m
HFXS 40 G	12907	40mm, corrugated conduit, light gauge	25m
HFXS 50 G	12908	50mm, corrugated conduit, light gauge	25m
HFXS 63 G	25054	63mm, corrugated conduit, light gauge	25m

## HFT Flexible Conduit Light Gauge (320N) - Black



Part No.	A-Code	Description	Pk Qty
HFXS 12 B	23654	12mm, corrugated conduit, light gauge,	50m
HFXS 16 B	23655	16mm, corrugated conduit, light gauge	50m
HFXS 20 B	23656	20mm, corrugated conduit, light gauge	50m
HFXS 25 B	23657	25mm, corrugated conduit, light gauge	50m
HFXS 32 B	23658	32mm, corrugated conduit, light gauge	25m
HFXS 40 B	23659	40mm, corrugated conduit, light gauge	25m
HFXS 50 B	23660	50mm, corrugated conduit, light gauge	25m
HFXS 63 B	23661	63mm, corrugated conduit, light gauge	25m



# Rigid Conduit & Accessories

Univolt's PVC LSF Conduit is the perfect solution for organising and protecting cables. A durable and easy to use solution, this product is available in a heavy or light gauge making it suitable for both indoor or outdoor use.

The Univolt conduit comes as PVC LSF standard.

- High impact and compression resistant
- Meets Standard EN61386-21
- UV stabilised
- REACH and RoHS compliant
- Available in both 20mm and 25mm diameter
- Black or White finish

Smoke Release (ISO5659-2:2012) - Standard PVC vs PVC/LSF\*

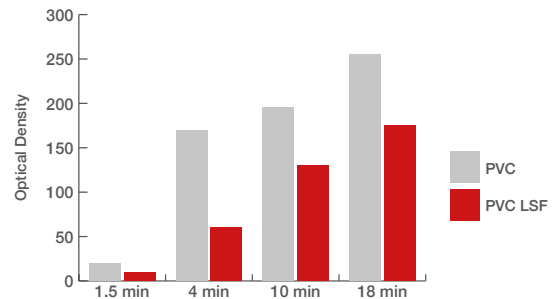

\* All figures refer to standardised test samples and are given to our best knowledge but without further commitment. It is Univolt's belief that information the information presented is accurate, Univolt makes no warranty, expressed or implied, with respect thereto and disclaims any liability from reliance thereon. All data are subject to change without prior notice.

**Standards**

Rigid conduits – Meets & exceeds BSEN61386-21  
 Conduit accessories – Meets & exceeds BSEN4607/5

## Rigid Conduit Light



Part No.	A-Code	Description	Pk Qty
BSSL 20 WH	108126	20mm Conduit, Light, White (3m)	90m
BSSL 25 WH	108127	25mm Conduit, Light, White (3m)	90m
BSSL 20 BK	108128	20mm Conduit, Light, Black (3m)	90m
BSSL 25 BK	108129	25mm Conduit, Light, Black (3m)	90m

## Rigid Conduit Heavy LSF

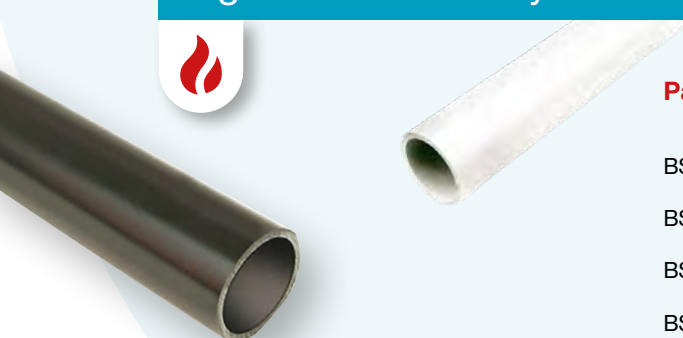

Part No.	A-Code	Description	Pk Qty
BSSH 20 WH LSF	103718	20mm Conduit, Heavy, White LSF (3m)	90m
BSSH 25 WH LSF	103719	25mm Conduit, Heavy, White LSF (3m)	90m
BSSH 20 BK LSF	105790	20mm Conduit, Heavy, Black LSF (3m)	90m
BSSH 25 BK LSF	105791	25mm Conduit, Heavy, Black LSF (3m)	90m

**\*NEW\*** LSF Conduit With Moulded On Coupler



Part of Univolt's next generation cable management range, the Fast Fix Conduit features a Moulded-on Coupler, designed to speed up and simplify installation, saving time and cost on site.

**Product information**

- Only available in heavy gauge
- Moulded on Coupler for speed of installation
- Available in both 20mm and 25mm diameter
- Black or White finish



Part No.	A-Code	Description	Pk Qty
BFFH 20 W LSF	108988	20mm Conduit Heavy, White LSF with Moulded on Coupler	90m
BFFH 25 W LSF	108989	25mm Conduit Heavy, White LSF with Moulded on Coupler	90m
BFFH 20 BK LSF	108991	20mm Conduit Heavy, Black LSF with Moulded on Coupler	90m
BFFH 25 BK LSF	108992	25mm Conduit Heavy, Black LSF with Moulded on Coupler	90m

**Fittings**

Couplers

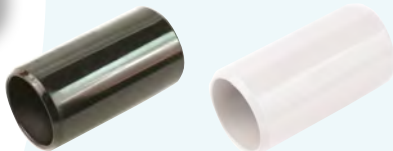

Part No.	A-Code	Description	Pk Qty
SM 20 WH	107501	20mm Couplers White	100pcs
SM 25 WH	107504	25mm Couplers White	50pcs
SM 20 BK	107502	20mm Couplers Black	100pcs
SM 25 BK	107503	25mm Couplers Black	50pcs

Spacer Bar Saddles



Part No.	A-Code	Description	Pk Qty
SBS 20 WH	107497	20mm Spacer Bar Saddles White	50pcs
SBS 25 WH	107498	25mm Spacer Bar Saddles White	50pcs
SBS 20 BK	107499	20mm Spacer Bar Saddles Black	50pcs
SBS 25 BK	107500	25mm Spacer Bar Saddles Black	50pcs

Metal Coated Spacer Bar Saddles



Part No.	A-Code	Description	Pk Qty
UNISB20WMSADDLE	103249	20mm Metal Coated White Spacer Bar Saddles	100pcs
UNISB25WMSADDLE	103250	25mm Metal Coated White Spacer Bar Saddles	100pcs
UNISB20BKSADDLE	108479	20mm Metal Coated Black Spacer Bar Saddles	100pcs
UNISB25BKSADDLE	108480	25mm Metal Coated Black Spacer Bar Saddles	100pcs

## Fittings *continued*

### Clips



Part No.	A-Code	Description	Pk Qty
CL 20 WH	107505	20mm Clips White	100pcs
CL 25 WH	107507	25mm Clips White	100pcs
CL 20 BK	107506	20mm Clips Black	100pcs
CL 25 BK	107508	25mm Clips Black	100pcs

### Nylon Kwik Clips



Part No.	A-Code	Description	Pk Qty
HKS 20 WH	57247	20mm Nylon Kwik Clip White	100pcs
HKS 25 WH	57250	25mm Nylon Kwik Clip White	100pcs
HKS 20 BK	57245	20mm Nylon Kwik Clip Black	100pcs
HKS 25 BK	57248	25mm Nylon Kwik Clip Black	100pcs

### Female Adaptors



Part No.	A-Code	Description	Pk Qty
AFT/MBS 20 WH	107489	20mm Female Adaptors White	100pcs
AFT/MBS 25 WH	107490	25mm Female Adaptors White	50pcs
AFT/MBS 20 BK	107491	20mm Female Adaptors Black	100pcs
AFT/MBS 25 BK	107492	25mm Female Adaptors Black	50pcs

### Male Adaptors



Part No.	A-Code	Description	Pk Qty
AMT/LR 20 WH	107493	20mm Male Adaptors White	100pcs
AMT/LR 25 WH	107494	25mm Male Adaptors White	50pcs
AMT/LR 20 BK	107495	20mm Male Adaptors Black	100pcs
AMT/LR 25 BK	107496	25mm Male Adaptors Black	50pcs

### Normal Bend



Part No.	A-Code	Description	Pk Qty
NB 20 WH	109903	20mm Normal Bend White	25pcs
NB 25 WH	109904	25mm Normal Bend White	10pcs
NB 20 BK	109868	20mm Normal Bend Black	25pcs
NB 25 BK	109869	25mm Normal Bend Black	10pcs

### Inspection Bend



Part No.	A-Code	Description	Pk Qty
IB 20 WH	108409	20mm Inspection Bend White	50pcs
IB 25 WH	108411	25mm Inspection Bend White	25pcs
IB 20 BK	108410	20mm Inspection Bend Black	50pcs
IB 25 BK	108412	25mm Inspection Bend Black	25pcs

### Inspection Elbow



Part No.	A-Code	Description	Pk Qty
IE 20 WH	108415	20mm Inspection Elbow White	50pcs
IE 25 WH	108417	25mm Inspection Elbow White	20pcs
IE 20 BK	108414	20mm Inspection Elbow Black	50pcs
IE 25 BK	108416	25mm Inspection Elbow Black	20pcs

Inspection Tee			Part No.	A-Code	Description	Pk Qty
				IT 20 WH	108417	20mm Inspection Tee White
			IT 25 WH	108419	25mm Inspection Tee White	20pcs
			IT 20 BK	108418	20mm Inspection Tee Black	50pcs
			IT 25 BK	108420	25mm Inspection Tee Black	20pcs

Terminal Box 1 Way			Part No.	A-Code	Description	Pk Qty
			CB 20/1 WH	104241	20mm Terminal 1 Way Box White	25pcs
			CB 25/1 WH	104246	25mm Terminal 1 Way Box White	25pcs
			CB 20/1 BK	104251	20mm Terminal 1 Way Box Black	25pcs
			CB 25/1 BK	104256	25mm Terminal 1 Way Box Black	25pcs

Through Box			Part No.	A-Code	Description	Pk Qty
			CB 20/2 WH	104242	20mm Through 2 Way Box White	25pcs
			CB 25/2 WH	104247	25mm Through 2 Way Box White	25pcs
			CB 20/2 BK	104252	20mm Through 2 Way Box Black	25pcs
			CB 25/2 BK	104257	25mm Through 2 Way Box Black	25pcs



**We listen to and collaborate with our wholesale partners who we recognise as being our direct line of communication to the contractor and welcome their expert knowledge and insight.**

Angle			Part No.	A-Code	Description	Pk Qty
				CB 20/A WH	104243	20mm Angle White
			CB 25/A WH	104248	25mm Angle White	25pcs
			CB 20/A BK	104253	20mm Angle Black	25pcs
			CB 25/A BK	104258	25mm Angle Black	25pcs

Tee 3 Way Box			Part No.	A-Code	Description	Pk Qty
				CB 20/3 WH	104244	20mm Tee 3 Way White
			CB 25/3 WH	104249	25mm Tee 3 Way White	20pcs
			CB 20/3 BK	104254	20mm Tee 3 Way Black	25pcs
			CB 25/3 BK	104259	25mm Tee 3 Way Black	20pcs



## Fittings *continued*

Intersection 4 Way



Part No.	A-Code	Description	Pk Qty
CB 20/4 WH	104245	20mm Intersection 4 Way White	20pcs
CB 25/4 WH	104250	25mm Intersection 4 Way White	10pcs
CB 20/4 BK	104255	20mm Intersection 4 Way Black	20pcs
CB 25/4 BK	104260	25mm Intersection 4 Way Black	10pcs

2 Way U Box



Part No.	A-Code	Description	Pk Qty
CB 20/2-U WH	9373	20mm Branch 2 Way White	20pcs
CB 25/2-U WH	9375	25mm Branch 2 Way White	20pcs
CB 20/2-U BK	9048	20mm Branch 2 Way Black	20pcs
CB 25/2-U BK	9050	25mm Branch 2 Way Black	20pcs

3 Way Y Box



Part No.	A-Code	Description	Pk Qty
CB 20/3-Y WH	9377	20mm Branch 3 Way White	20pcs
CB 25/3-Y WH	9379	25mm Branch 3 Way White	20pcs
CB 20/3-Y BK	9052	20mm Branch 3 Way Black	20pcs
CB 25/3-Y BK	9054	25mm Branch 3 Way Black	20pcs

4 Way Box



Part No.	A-Code	Description	Pk Qty
CB 20/4-H WH	9381	20mm Twin Through Way White	20pcs
CB 25/4-H WH	9383	25mm Twin Through Way White	20pcs
CB 20/4-H BK	9056	20mm Twin Through Way Black	20pcs
CB 25/4-H BK	9058	25mm Twin Through Way Black	20pcs

Loop In Box 4 Hole



Part No.	A-Code	Description	Pk Qty
LIB 20/4W	9311	20mm Loop in Box 4 Hole White	25pcs
LIB 20/4B	8978	20mm Loop in Box 4 Hole Black	25pcs

Reducer



Part No.	A-Code	Description	Pk Qty
R 25x20 WH	9321	25mm - 20mm Reducer White	50pcs
R 25x20 BK	8992	25mm - 20mm Reducer Black	50pcs



**Univolt**, whose headquarters are in Vienna, Austria - is committed to operating a business based upon sustainable principles, in line with the wider vision of its homeland.

Circular Lids



Part No.	A-Code	Description	Pk Qty
CBL 16-25 WH	104267	16-25mm Circular Lids White	100pcs
CBL 16-25 BK	104269	16-25mm Circular Lids Black	100pcs

Sealing Cement



Part No.	A-Code	Description	Pk Qty
VKS 250/1	87261	250ml Sealing Cement	1pc

Bending Spring L/G



Part No.	A-Code	Description	Pk Qty
BSL 20	9135	20mm Bending Spring L/G	1pc
BSL 25	9136	25mm Bending Spring L/G	1pc

Bending Spring H/G



Part No.	A-Code	Description	Pk Qty
BS 20	96793	20mm Bending Spring H/G	1pc
BS 25	8913	25mm Bending Spring H/G	1pc



# Mini Trunking - PVC LSF



Univolt Mini Trunking supports and contains power and data cable installation for any domestic or commercial installation.

A simple to use and accessible cable management solution, Univolt's Mini Trunking is easy to handle and offers full accessibility for wiring or rewiring.

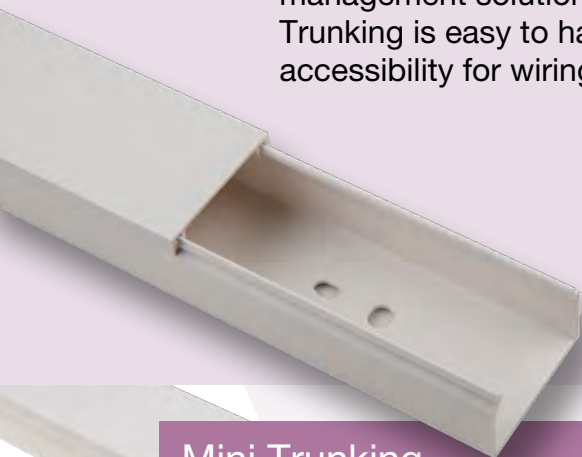

## Product Information

Manufactured from high quality PVC, with guaranteed durability and longevity

- All Mini Trunkings come as PVC LSF as standard
- Pre-punched holes, for ease of installation
- Available in both a standard finish as well as self-adhesive
- The lid can be simply snapped into place and sealed securely
- Various depths of supporting boxes
- EN50085 and BS4678 Part 4 compliant

## Mini Trunking



Part No.	A-Code	Description	Pk Qty
MIK 10/16 WH	106601	10x16mm Mini Trunking 3m	60m
MIK 16/16 WH	106602	16x16mm Mini Trunking 3m	60m
MIK 16/25 WH	106603	16x25mm Mini Trunking 3m	60m
MIK 16/40 WH	106604	16x40mm Mini Trunking 3m	60m
MIK 25/40 WH	106605	25x40mm Mini Trunking 3m	30m
MIK 25/40/2 WH	106606	25x40mm Mini Trunking 2 Comp, 3m	30m
MIK 40/40 WH	106607	40x40mm Mini Trunking 3m	30m
MIK 40/60 WH	106608	40x60mm Mini Trunking 3m	30m

## Self Adhesive Mini



Part No.	A-Code	Description	Pk Qty
MIKA 0 WH	106609	10x16mm Self Adhesive Mini Trunking 3m	60m
MIKA 1 WH	106610	16x16mm Self Adhesive Mini Trunking 3m	60m
MIKA 2 WH	106611	16x25mm Self Adhesive Mini Trunking 3m	60m
MIKA 3 WH	106612	16x40mm Self Adhesive Mini Trunking 3m	60m
MIKA 4 WH	106613	25x40mm Self Adhesive Mini Trunking 3m	30m
MIKA 5 WH	106614	40x40mm Self Adhesive Mini Trunking 3m	30m

## Fittings

Internal Angle



Part No.	A-Code	Description	Pk Qty
SIE 16/16 WH	4966	16x16mm Internal Angles	20pcs
SIE 16/25 WH	4967	16x25mm Internal Angles	10pcs
SIE 16/40 WH	4969	16x40mm Internal Angles	10pcs
SIE 25/40 WH	4970	25x40mm Internal Angles	10pcs
SIE 40/40 WH	23005	40x40mm Internal Angles	10pcs
SIE 40/60 WH	23613	40x60mm Internal Angles	1pc

External Angle



Part No.	A-Code	Description	Pk Qty
SAE 16/16 WH	4961	16x16mm External Angles	20pcs
SAE 16/25 WH	4964	16x25mm External Angles	10pcs
SAE 16/40 WH	4962	16x40mm External Angles	10pcs
SAE 25/40 WH	4963	25x40mm External Angles	10pcs
SAE 40/40 WH	23004	40x40mm External Angles	10pcs
SAE 40/60 WH	23614	40x60mm External Angles	1pc

Flat Angle



Part No.	A-Code	Description	Pk Qty
SFW 16/16 WH	4956	16x16mm Flat Angles	20pcs
SFW 16/25 WH	4957	16x25mm Flat Angles	10pcs
SFW 16/40 WH	4958	16x40mm Flat Angles	5pcs
SFW 25/40 WH	4959	25x40mm Flat Angles	5pcs
SFW 40/40 WH	23003	40x40mm Flat Angles	5pcs
SFW 40/60 WH	23612	40x60mm Flat Angles	1pc

Tee

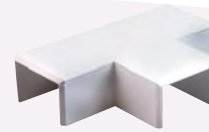

Part No.	A-Code	Description	Pk Qty
ST 16/16 WH	4971	16/x6mm Tee	10pcs
ST 16/25 WH	4974	16x25mm Tee	10pcs
ST 16/40 WH	4972	16x40mm Tee	10pcs
ST 25/40 WH	4973	25x40mm Tee	5pcs
ST 40/40 WH	23006	40x40mm Tee	5pcs
ST 40/60 WH	23611	40x60mm Tee	1pc

Couplers

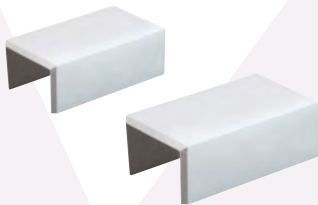

Part No.	A-Code	Description	Pk Qty
SK 16/16 WH	4951	16x16mm Couplers	20pcs
SK 16/25 WH	4952	16x25mm Couplers	20pcs
SK 16/40 WH	4953	16x40mm Couplers	20pcs
SK 25/40 WH	4954	25x40mm Couplers	20pcs
SK 40/40 WH	4955	40x40mm Couplers	10pcs
SK 40/60 WH	25614	40x60mm Couplers	5pcs

## SETTING THE STANDARD IN CABLE MANAGEMENT SAFETY

**OUR UNIQUE PVC-LSF (LOWER SMOKE FUME) PRODUCT OFFERS A HIGHER IGNITION POINT OF UP TO 15% THAN STANDARD PVC**

The halogens it contains are released at a slower rate, therefore, smoke release is also reduced by up to 60% in the first four minutes of a fire when compared to standard PVC.

**At the same price point of competitor products, the question is why wouldn't you..?**





		Part No.	A-Code	Description	Pk Qty
Stop ends		SE 16/16 WH	4977	16x16mm Stop Ends	50pcs
		SE 16/25 WH	4978	16x25mm Stop Ends	50pcs
		SE 16/40 WH	4979	16x40mm Stop Ends	20pcs
		SE 25/40 WH	4980	25x40mm Stop Ends	20pcs
		SE 40/40 WH	4981	40x40mm Stop Ends	20pcs
		SE 40/60 WH	25613	40x60mm Stop Ends	10pcs
Intersections		SWAL 16/25 WH	4982	16x25mm Left Intersection	10pcs
		SWAR 16/25 WH	4983	16x25mm Right Intersection	10pcs
		SA 16/25 WH	4984	16x25mm Side Tee	10pcs
Mini trunking adaptors		SKE 16/16 White DG WH	109714	16x16mm Trunking Adaptor White	1pc
		SKE 16/25 White DG WH	109715	16x25mm Trunking Adaptor White	1pc

## Red Coloured Trunking



	Part No.	A-Code	Description	Pk Qty
	MIK 16/25 RED	108959	16x25mm Mini Trunking Red PVC 3m	60m
	MIKA 2 RED	108958	16x25mm Self Adhesive Mini Trunking Red PVC 3m	60m

## Fittings

		Part No.	A-Code	Description	Pk Qty
Internal & External Angle		SIE 16/25 RED	109522	16x25mm Internal Angles Red	10pcs
		SAE 16/25 RED	109520	16x25mm External Angles Red	10pcs
Flat Angle & Tee		SFW 16/25 RED	109521	16x25mm Flat Angles Red	10pcs
		ST 16X25/16X25 RED	109524	16x25mm Flat Tee Red	10pcs
Stop End & Coupler		SE 16/25 RED	57078	16x25mm Stop Ends Red	50pcs
		SK 16/25 RED	109523	16x25mm Couplers Red	20pcs
Mini Trunking Adaptors		SKE 16/16 RED DG	109712	16x16mm Trunking Adaptor Red	1pc
		SKE 16/25 RED DG	109713	16x25mm Trunking Adaptor Red	1pc

## Black Coloured Mini Trunking



Part No.	A-Code	Description	Pk Qty
MIKA 2 Black	109709	16x25mm Self Adhesive Mini Trunking Black	60m

## Fittings

Mini trunking Adaptors

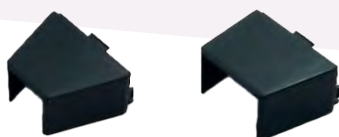

Part No.	A-Code	Description	Pk Qty
SKE 16/16 BK DG	109710	16x16mm Trunking Adaptor Black	1pc
SKE 16/25 BK DG	109711	16x25mm Trunking Adaptor Black	1pc

## Brown Coloured Mini Trunking

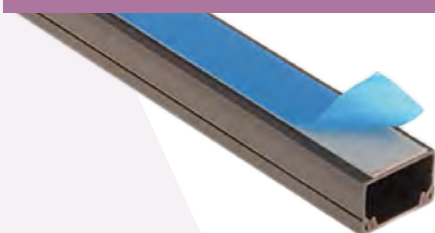

Part No.	A-Code	Description	Pk Qty
MIK 16/25 BROWN	98020	16x25mm Mini Trunking Brown PVC 3m	60m
MIKA 2 BROWN	98019	16x25mm Self Adhesive Mini Trunking Brown PVC 3m	60m

## Oval Conduit

Oval Conduit

Part No.	A-Code	Description	Pk Qty
UFR 16	108494	16mm Oval Conduit White	150m
UFR 20	103720	20mm Oval Conduit White	150m
UFR 25	103721	25mm Oval Conduit White	150m

## Channelling

Oval Channel

Part No.	A-Code	Description	Pk Qty
CHA 1	108332	12mm Channelling White (150m Bundle) 2m length	150m
CHA 2	108333	25mm Channelling White (150m Bundle) 2m length	150m
CHA 3	108334	38mm Channelling White (150m Bundle) 2m length	150m

**\*NEW\***

## Oval Clips

Oval Clips



Part No.	A-Code	Description	Pk Qty
109942	OCL 16 DG	Quick clip for 16mm Oval	100
109943	OCL 20 DG	Quick clip for 20mm Oval	100
109944	OCL 25 DG	Quick clip for 25mm Oval	100



# Surface Boxes - PVC LSF

The Univolt Surface Box is the perfect solution for surface mounting switches and sockets, with a bright White finish and a choice of rounded or square corners.

The Surface Box can be simply mounted and fixed onto any surface, providing a secure base for switches and sockets, and comes with a 20/25mm Conduit and Mini Trunking knockout that provides added flexibility for cable entry.

Manufactured using quality PVC, this durable product is lightweight and robust, supporting a simple installation.

## Product information

- PVC LSF as standard
- Round and square corners available
- 1 x Mini Trunking Knockout (adaptors available)
- 1 x 20/25mm Conduit Knockout
- One and two Gang Boxes are available in two depths: 32mm and 44mm

## Twin & Single Surface Box Square and Round Cornered



Part No.	A-Code	Description	Pk Qty
SFB1/32	103220	Single 32mm Surface Box Square Corner 1xMT K.O & 1x Conduit K.O	10pcs
SFB2/32	103222	Twin 32mm Surface Box Square Corner 1xMT K.O & 1x Conduit K.O	10pcs
SFB1/44	103224	Single 44mm Surface Box Square Corner 1xMT K.O & 1x Conduit K.O	10pcs
SFB2/44	103226	Twin 44mm Surface Box Square Corner 1xMT K.O & 1x Conduit K.O	10pcs
SFR1/32	103221	Single 32mm Surface Box Round Corner 1xMT K.O & 1x Conduit K.O	10pcs
SFR2/32	103223	Twin 32mm Surface Box Round Corner 1xMT K.O & 1x Conduit K.O	10pcs
SFR1/44	103225	Single 44mm Surface Box Round Corner 1xMT K.O & 1x Conduit K.O	10pcs
SFR2/44	103227	Twin 44mm Surface Box Round Corner 1xMT K.O & 1x Conduit K.O	10pcs

## Fittings

Trunking  
Adaptor



Part No.	A-Code	Description	Pk Qty
SKE 16/16	4986	16x16mm Trunking Adaptor	1pc
SKE 16/25	4987	16x25mm Trunking Adaptor	1pc

**\*NEW\***

## Surface Boxes – No adaptor needed

The new Univolt Surface Box is an ideal solution for mounting switches and sockets onto any surface.

Following customer feedback, the new Surface Box matches the colour of the Univolt Conduit and Mini Trunking, with no requirement for a Mini Trunking Adaptor. The Mini Trunking simply covers the cut out on the Surface Box for 25x16mm standard, or self-adhesive Mini Trunking, offering a neat solution for cable entry.

The Univolt Surface Box is available with round and square edges, with a depth of 32mm. Manufactured using quality PVC, this durable product is lightweight and robust, supporting a simple installation.

### Product information

- PVC LSF as standard
- No requirement for Mini Trunking adaptors.
- Single Gang Box has 1 x Mini Trunking Knockout (22x12mm), and 1 x 20/25mm Conduit Knockout
- Double Gang Box has 3 x Mini Trunking Knockout (22x12mm), and 3 x 20/25mm Conduit Knockout
- Meets IEC 60670 standard



Part No.	A-Code	Description	Pk Qty
BBS1	109586	Single Square Corner Surface Box No Adaptor 32mm	10pcs
BBS2	109587	Twin Square Corner Surface Box No Adaptor 32mm	10pcs
BBR1	109584	Single Round Corner Surface Box, No Adaptor 32mm	10pcs
BBR2	109585	Twin Round Corner Surface Box, No Adaptor 32mm	10pcs

In 1995, Univolt was awarded the ISO 9001 certificate for its quality assurance system. The monitoring of quality, from design and development to production and application, guarantees customers a comprehensive assurance of high standards throughout the manufacturing process.



**\*NEW\***

## Red Surface Boxes Square Corner - PVC Only

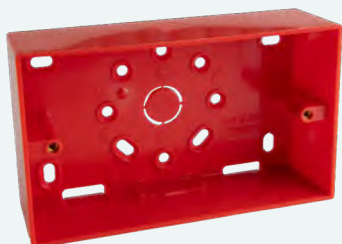

Part No.	A-Code	Description	Pk Qty
SFB 1/32 RED	108976	Single 32mm Surface Box Square Corner 1xMT K.O & 1x Conduit KO Red	10pcs
SFB 2/32 RED	108977	Twin 32mm Surface Box Square Corner 1xMT K.O & 1x Conduit KO Red	10pcs
SFB 1/44 RED	108980	Single 44mm Surface Box Square Corner 1xMT K.O & 1x Conduit KO Red	10pcs
SFB 2/44 RED	108981	Twin 44mm Surface Box Square Corner 1xMT K.O & 1x Conduit KO Red	10pcs

**\*NEW\***

## Red Surface Boxes Round Corner - PVC Only



Part No.	A-Code	Description	Pk Qty
SFR 1/32 RED	108974	Single 32mm Surface Box Round Corner 1xMT K.O & 1x Conduit KO Red	10pcs
SFR 2/32 RED	108975	Twin 32mm Surface Box Round Corner 1xMT K.O & 1x Conduit K.O Red	10pcs
SFR 1/44 RED	108978	Single 44mm Surface Box Round Corner 1xMT K.O & 1x Conduit K.O Red	10pcs
SFR 2/44 RED	108979	Twin 44mm Surface Box Round Corner 1xMT K.O & 1x Conduit K.O Red	10pcs

## Fittings

Mini Trunking Adaptors

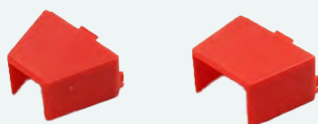

Part No.	A-Code	Description	Pk Qty
SKE 16/16 RED DG	109712	16x16mm Trunking Adaptor Red	1pc
SKE 16/25 RED DG	109713	16x25mm Trunking Adaptor Red	1pc



Univolt is part of the UN Global Compact initiative, a global movement of sustainable companies and stakeholders committed to behaving responsibly by aligning their strategies and operations with Ten Principles on human rights, labour, environment and anti-corruption.



**Strong foundations -**  
Dietzel Univolt was founded in 1938 by the Dietzel family who continue to own and operate the company to this day.

**\*NEW\***

### Black Surface Boxes Square Corner - PVC LSF



Part No.	A-Code	Description	Pk Qty
SFB 1/32 BK	108988	Single 32mm Surface Box Square Corner 1xMT K.O & 1x Conduit KO Black	10pcs
SFB 2/32 BK	108969	Twin 32mm Surface Box Square Corner 1xMT K.O & 1x Conduit KO Black	10pcs
SFB 1/44 BK	108972	Single 44mm Surface Box Square Corner 1xMT K.O & 1x Conduit KO Black	10pcs
SFB 2/44 BK	108973	Twin 44mm Surface Box Square Corner 1xMT K.O & 1x Conduit KO Black	10pcs

**\*NEW\***

### Black Surface Boxes Round Corner - PVC LSF



Part No.	A-Code	Description	Pk Qty
SFR 1/32 BK	108966	Single 32mm Surface Box Round Corner 1xMT K.O & 1x Conduit KO Black	10pcs
SFR 2/32 BK	108967	Twin 32mm Surface Box Round Corner 1xMT K.O & 1x Conduit K.O Black	10pcs
SFR 1/44 BK	108970	Single 44mm Surface Box Round Corner 1xMT K.O & 1x Conduit K.O Black	10pcs
SFR 2/44 BK	108971	Twin 44mm Surface Box Round Corner 1xMT K.O & 1x Conduit K.O Black	10pcs

## Fittings

Mini Trunking Adaptors

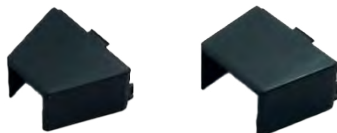

Part No.	A-Code	Description	Pk Qty
SKE 16/16 BK DG	109710	16x16mm Trunking Adaptor Black	1pc
SKE 16/25 BK DG	109711	16x25mm Trunking Adaptor Black	1pc



# Maxi Trunking

Univolt's Maxi Trunking is highly durable, lightweight and easy to handle and install, as well as being cost effective.

A perfect solution for the safe and secure distribution of power and data, this trunking solution is available in a range of sizes and can be used across multiple sectors, spaces and environments, new build developments as well as refurbishments.

### Product information

- Coming soon in PVC-LSF
- Now with pre-punched base
- High impact resistant
- Supplied with a secure fix lid
- 10 sizes available
- Back Boxes available for both power and data
- Pre-assembled units available saving time on installation
- EN50085 and BS4678 Part 4 compliant



Maxi Trunking

Part No.	A-Code	Description	Pk Qty
MAK50/50*	109926	50x50mm Maxi Trunking	12m
MAK50/75	19007	50x75mm Maxi Trunking	12m
MAK50/100*	109928	50x100mm Maxi Trunking	12m
MAK50/150	22788	50x150mm Maxi Trunking	6m
MAK75/75*	09927	75x75mm Maxi Trunking	12m
MAK75/100	19010	75x100mm Maxi Trunking	6m
MAK75/150	22953	75x150mm Maxi Trunking	6m
MAK100/100	19011	100x100mm Maxi Trunking	6m
MAK100/150	22789	100x150mm Maxi Trunking	3m
MAK150/150	22790	150x150mm Maxi Trunking	3m



\* Coming soon in PVC-LSF, with pre-punched base.

**MAK50/100 can be installed as a Dado Trunking for both power and data cables**

MAK50/100 is compatible with MIB60/100 Single Backbox and MIB120/100 Twin Backbox.



Fittings

Internal Angles

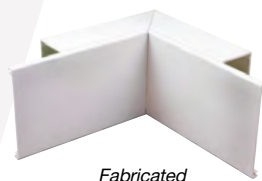
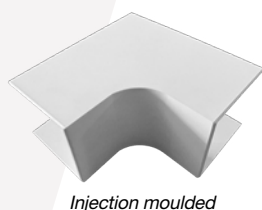

Part No.	A-Code	Description	Pk Qty
MIE50/50	19250	50x50mm Internal Angle - FABRICATED	1pc
MIE50/50DG*	110179	50x50mm Internal Angle - INJECTION MOULDED	1pc
MIE50/75	19251	50x75mm Internal Angle - FABRICATED	1pc
MIE50/100	19252	50x100mm Internal Angle - FABRICATED	1pc
MIE50/100DG*	110186	50X100mm Internal Angle - INJECTION MOULDED	1pc
MIE50/150	22958	50x150mm Internal Angle - FABRICATED	1pc
MIE75/75	19253	75x75mm Internal Angle - FABRICATED	1pc
MIE75/75DG*	110184	75x75mm Internal Angle - INJECTION MOULDED	1pc
MIE75/100	19254	75x100mm Internal Angle - FABRICATED	1pc
MIE75/150	22959	75x150mm Internal Angle - FABRICATED	1pc
MIE100/100	19255	100x100mm Internal Angle - FABRICATED	1pc
MIE100/150	22960	100x150mm Internal Angle - FABRICATED	1pc
MIE150/150	22961	150x150mm Internal Angle - FABRICATED	1pc

External Angles



Part No.	A-Code	Description	Pk Qty
MAE50/50	19262	50x50mm External Angle - FABRICATED	1pc
MAE50/50DG*	110188	50x50 External Angle- INJECTION MOULDED	1pc
MAE50/75	19263	50x75mm External Angle - FABRICATED	1pc
MAE50/100	19264	50x100mm External Angle - FABRICATED	1pc
MAE50/100DG*	110194	50X50mm External Angle - INJECTION MOULDED	1pc
MAE50/150	22962	50x150mm External Angle - FABRICATED	1pc
MAE75/75	19265	75x75mm External Angle - FABRICATED	1pc
MAE75/75DG*	110190	75X75mm External Angle - INJECTION MOULDED	1pc
MAE75/100	19266	75x100mm External Angle - FABRICATED	1pc
MAE75/150	22963	75x150mm External Angle - FABRICATED	1pc
MAE100/100	19267	100x100mm External Angle - FABRICATED	1pc
MAE100/150	22964	100x150mm External Angle - FABRICATED	1pc
MAE150/150	22965	150x150mm External Angle - FABRICATED	1pc

Flat Tee

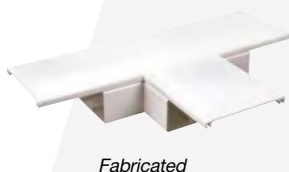

Part No.	A-Code	Description	Pk Qty
MFT50/50	19274	50x50mm Flat Tee - FABRICATED	1pc
MFT50/50DG*	110198	50X50mm Flat Tee - INJECTION MOULDED	1pc
MFT50/75	19275	50x75mm Flat Tee - FABRICATED	1pc
MFT50/100	19276	50x100mm Flat Tee - FABRICATED	1pc
MFT50/100DG*	110200	50X100mm Flat Tee - INJECTION MOULDED	1pc
MFT50/150	22970	50x150mm Flat Tee - FABRICATED	1pc
MFT75/75	19277	75x75mm Flat Tee - FABRICATED	1pc
MFT75/75DG*	110199	75X75mm Flat Tee - INJECTION MOULDED	1pc
MFT75/100	19278	75x100mm Flat Tee - FABRICATED	1pc
MFT75/150	22971	75x150mm Flat Tee - FABRICATED	1pc
MFT100/100	19279	100x100mm Flat Tee - FABRICATED	1pc
MFT100/150	22972	100x150mm Flat Tee - FABRICATED	1pc
MFT150/150	22973	150x150mm Flat Tee - FABRICATED	1pc



\* Coming soon in PVC-LSF.

## Fittings *continued*

Flat Angle

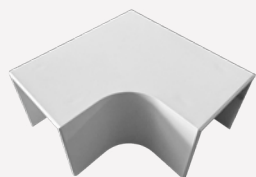

*Injection moulded*



*Fabricated*

Part No.	A-Code	Description	Pk Qty
MFW50/50	19286	50x50mm Flat Angle - FABRICATED	1pc
MFW50/50DG*	110195	50X50mm Flat Angle - INJECTION MOULDED	1pc
MFW50/75	19287	50x75mm Flat Angle - FABRICATED	1pc
MFW50/100	19288	50x100mm Flat Angle - FABRICATED	1pc
MFW50/100DG*	110197	50X100mm Flat Angle - INJECTION MOULDED	1pc
MFW50/150	22966	50x150mm Flat Angle - FABRICATED	1pc
MFW75/75	19289	75x75mm Flat Angle - FABRICATED	1pc
MFW75/75DG*	110196	75X75mm Flat Angle - INJECTION MOULDED	1pc
MFW75/100	19290	75x100mm Flat Angle - FABRICATED	1pc
MFW75/150	22967	75x150mm Flat Angle - FABRICATED	1pc
MFW100/100	19291	100x100mm Flat Angle - FABRICATED	1pc
MFW100/150	22968	100x150mm Flat Angle - FABRICATED	1pc
MFW150/150	22969	150x150mm Flat Angle - FABRICATED	1pc

Internal Coupler



Part No.	A-Code	Description	Pk Qty
MIC50	37544	50mm Internal Coupler	1pc
MIC75	37545	75mm Internal Coupler	1pc
MIC100	37543	100mm Internal Coupler	1pc
MIC150	37542	150mm Internal Coupler	1pc

Cable Retainer



Part No.	A-Code	Description	Pk Qty
MHK50	19329	50mm Cable Retainer	1pc
MHK75	19330	75mm Cable Retainer	1pc
MHK100	19331	100mm Cable Retainer	1pc



\* Coming soon in PVC-LSF.



A company-wide program is run to reduce the consumption of energy and the use of water in order to preserve natural resources. Where suitable, Univolt use post-consumer waste, thus reducing the amount of plastic waste.

Stop End



Part No.	A-Code	Description	Pk Qty
ME50/50	19308	50x50mm Stop End	1pc
ME50/50WHDG*	110201	50X50mm Stop End	1pc
ME50/75	19309	50x75mm Stop End	1pc
ME50/100	19310	50x100mm Stop End	1pc
ME50/100DG*	110204	50X100mm Stop End	1pc
ME50/150	22163	50x150mm Stop End	1pc
ME75/75	19311	75x75mm Stop End	1pc
ME75/75DG*	110203	75X75mm Stop End	1pc
ME75/100	19312	75x100mm Stop End	1pc
ME75/150	22165	75x150mm Stop End	1pc
ME100/100	19313	100x100mm Stop End	1pc
ME100/150	22167	100x150mm Stop End	1pc
ME150/150	22169	150x150mm Stop End	1pc

Cover Joint



Part No.	A-Code	Description	Pk Qty
MK50WS	19317	50mm Cover Joint	1pc
MK75WS	19318	75mm Cover Joint	1pc
MK100WS	19319	100mm Cover Joint	1pc
MK150WS	25055	150mm Cover Joint	1pc

Trunking Divider



Part No.	A-Code	Description	Pk Qty
MTW50	19717	50mm Trunking Divider	3m
MTW75	19718	75mm Trunking Divider	3m
MTW100	19719	100mm Trunking Divider	3m

*MAK 50/50 and MAK 150/150 will not accept divider strip*

Single & Twin Socket



Part No.	A-Code	Description	Pk Qty
MIB60/100-2	108122	Single Socket Box 80x100x28mm 2 Lugs	1pc
MIB60/100-4	23230	Single Socket Box 80x100x28mm 4 Lugs	1pc
MIB120/100	23232	Twin Socket Box 140x100x28mm	1pc
MIB60/150	23231	Single Socket Box 80x150x28mm	1pc
MIB120/150	23233	Twin Socket Box 140x150x28mm	1pc



\* Coming soon in PVC-LSF.



# Starline SLR 3 Comp Curved Trunking

Univolt's SLR 3 compartment Dado Trunking offers an innovative solution for the growing data-cabling market. At 170x50mm, the curved design allows for the installation of both power and high-density structured cabling systems including Cat5e, Cat6, Cat6A, Cat7 and the latest Cat8 solution.

These latest accessories are now injection moulded, allowing a minimum bend radius of 50mm. The SLR Dado is also available with a Light Grey centre lid, and is fully DDA (Part M) compliant.

### Product information

- 50x170mm aesthetic curved profile
- Cat5e, Cat6, Cat6A, Cat7 and the latest Cat8 compliant Dado
- Coming soon in PVC-LSF
- Pre-punched base
- Min 50mm bend radius
- Adjustable internal and external angles (+/- 10 degrees)
- Moulded Flat Angles and Tees for ease of installation
- Will accept our new Single and Twin adjustable Back Boxes (30mm - 50mm)
- Available in Light Grey lid for DDA compliance
- EN50085 BS46784 compliant

Material

PVC-U



flame retardant



-25 °C/+60 °C



2J

## SLR



### Part No.

SLR 50/170DG\*

### A-Code

109929

### Description

170x50mm 3 Comp Dado curved edge, Cat5e, Cat6, Cat6A & Cat8 compliant

### Pk Qty

3m

\* Coming soon in PVC-LSF, with pre-punched base.

## SLR LGL



### Part No.

SLR 50/170LGL\*

### A-Code

105311

### Description

Dado Trunking Curved Profile c/w Light Grey Lid to meet DDA compliance

### Pk Qty

3m

\* Coming soon in PVC-LSF, with pre-punched base.

## Fittings

Internal Angle



### Part No.

SLRIA 50/170

### A-Code

108799

### Description

Adjustable Internal Angle - CAT6/6A/7/8

### Pk Qty

1pc

Fittings *continued*

External Angles			<b>Part No.</b>	<b>A-Code</b>	<b>Description</b>	<b>Pk Qty</b>
			SLREA 50/170	108800	Adjustable External Angle - CAT6/6A/7/8	1pc
Flat Angles			<b>Part No.</b>	<b>A-Code</b>	<b>Description</b>	<b>Pk Qty</b>
			SLRFA 50/170	108801	Flat Angle - Cat6/6A/7/8	1pc
Flat Tees			<b>Part No.</b>	<b>A-Code</b>	<b>Description</b>	<b>Pk Qty</b>
			SLRFT 50/170	108802	Flat Tee Dado Rounded - Cat6/6a/7/8	1pc
Take Off Adaptor			<b>Part No.</b>	<b>A-Code</b>	<b>Description</b>	<b>Pk Qty</b>
			SLRTOA 50/170	108803	Take Off Adaptor Conduit & Mini	1pc
Cover Joint			<b>Part No.</b>	<b>A-Code</b>	<b>Description</b>	<b>Pk Qty</b>
			RK 50/170	101590	Coupler Dado Rounded	1pc
End Caps			<b>Part No.</b>	<b>A-Code</b>	<b>Description</b>	<b>Pk Qty</b>
			RE 50/170	101120	End Cap Dado Rounded	1pc
Back Boxes			<b>Part No.</b>	<b>A-Code</b>	<b>Description</b>	<b>Pk Qty</b>
			SLB1-A	104560	Adjustable Single box 30mm-50mm	1pc
			SLB2-A	104561	Adjustable Twin box 30mm-50mm	1pc
Spare Lid			<b>Part No.</b>	<b>A-Code</b>	<b>Description</b>	<b>Pk Qty</b>
			SLR42/50	101429	Curved Lid (1x3m)	3m
			SL80	82106	Centre Lid (2x3m)	6m
			SL80 LG	85666	Centre Lid Only Light Grey	3m

# SLXL

The new Starline SLXL PVC LSF has been designed for use in both power, and the latest structured cabling including CAT5e, CAT6, CAT6A, CAT7, OM3 Fibre and the new CAT8 high density data solution.

At 210mm x 65mm, the SLXL PVC LSF is one of the largest 3 compartment Dado products on the market, allowing extra data capacity where high levels of data are required.

SLXL was designed for various market sectors including education, health, MOD and data centres, as well as commercial and industrial applications.

Univolt's SLXL PVC LSF achieves DDA compliance (Disability Discrimination Act 2005), through the use of a Light Grey coloured centre lid. The high impact resistance PVC assures the trunking is both sturdy and robust, whilst providing an aesthetically pure White finish.

### Product information

- 210x65mm aesthetic curved profile
- SLXL PVC - LSF (Lower smoke and fume) reduces smoke release by up to 65% in the first 4 minutes of a fire
- Will accept the latest structured cabling solutions – CAT5e, CAT6, CAT6A, CAT7, CAT8
- New adjustable Back Box (30mm – 50mm), for deeper RJ45 outlets
- Adjustable internal and external bends +/- 10 degrees
- Moulded internal, external, Flat Angle and Flat Tee offer a minimum bend radius of 70mm
- DDA compliance with Light Grey centre lid

Material  
PVC-U



flame retardant



-25 °C/+60 °C



2J

## SLXL - PVC LSF



Part No.	A-Code	Description	Pk Qty
SLXL65/210 LSF	104553	210x65mm curved 3 comp dado Cat5e/6/6A/7/8 & OM3 Fibre PVC LSF	3m

## SLXL LGL - PVC LSF



Part No.	A-Code	Description	Pk Qty
SLXL65/210 LSF-LGL	106745	210x65mm curved 3 comp dado Light Grey center Lid for DDA compliance PVC LSF	3m

## Fittings - PVC LSF

Internal Angle			<b>Part No.</b>	<b>A-Code</b>	<b>Description</b>	<b>Pk Qty</b>
			SLIA LSF	104556	Internal Adjustable Angle-lower smoke	1pc
External Angle			<b>Part No.</b>	<b>A-Code</b>	<b>Description</b>	<b>Pk Qty</b>
			SLOA LSF	104559	External Adjustable Angle-lower smoke	1pc
Flat Angles			<b>Part No.</b>	<b>A-Code</b>	<b>Description</b>	<b>Pk Qty</b>
			SLFA LSF	104557	Flat Angle-lower smoke	1pc
Flat Tees			<b>Part No.</b>	<b>A-Code</b>	<b>Description</b>	<b>Pk Qty</b>
			SLFT LSF	104562	Flat Tee SLXL	1pc
Cable Retainer			<b>Part No.</b>	<b>A-Code</b>	<b>Description</b>	<b>Pk Qty</b>
			SLCR LSF	104563	Cable Retainer-lower smoke	1pc
Coupler			<b>Part No.</b>	<b>A-Code</b>	<b>Description</b>	<b>Pk Qty</b>
			SLC LSF	104554	Joint Cover-lower smoke	1pc
End Caps			<b>Part No.</b>	<b>A-Code</b>	<b>Description</b>	<b>Pk Qty</b>
			SLE LSF	104555	End Cap-lower smoke	1pc
Back Boxes			<b>Part No.</b>	<b>A-Code</b>	<b>Description</b>	<b>Pk Qty</b>
			SLB1-A	104560	Adjustable Single box 30mm-50mm	1pc
			SLB2-A	104561	Adjustable Twin box 30mm-50mm	1pc

# SLC

The SLC 50x170 is designed for a broad range of installations including public sector, education and health, as well as commercial and industrial environments.

Also available in pre-assembled units, saving time and money on installation, SLC is ideal for student accommodation or modular build.

### Product information

- 170x50mm chamfer/chamfer
- High impact resistant
- Will only accept SLB1 and SLB2 Single and Twin Back Boxes
- DDA compliance with Light Grey centre lid option

Material

PVC-U



flame retardant



-25 °C/+60 °C



2J

## SLC



Part No.	A-Code	Description	Pk Qty
SLC 50/170	82756	Dado Trunking Chamfered	3m

## Fittings

Internal Angle



Part No.	A-Code	Description	Pk Qty
CIE 50/170	36066	Internal Angle Dado Chamfered	1pc

External Angle



Part No.	A-Code	Description	Pk Qty
CAE 50/170	36067	External Bend Dado Chamfered	1pc

Fittings *continued*

Flat Angles



Part No.	A-Code	Description	Pk Qty
CFW 50/170	36729	Flat Angles Dado Chamfered	1pc

Flat Tees



Part No.	A-Code	Description	Pk Qty
CFT 50/170	36783	Flat Tees Dado Chamfered	1pc

Coupler



Part No.	A-Code	Description	Pk Qty
CK 50/170	36068	Coupler Dado Chamfered	1pc

End Caps



Part No.	A-Code	Description	Pk Qty
CE 50/170	36069	End Cap Dado Chamfered	1pc

Back Boxes



Part No.	A-Code	Description	Pk Qty
SLB 1	36075	Fixed Single Socket Box	1pc
SLB 2	36076	Fixed Twin Socket Box	1pc

Spare Lid



Part No.	A-Code	Description	Pk Qty
SLC 42/50	81971	Chamfered Lid Only (4x3m)	12m
SL80	82106	Centre Lid (2x3m)	6m
SL80 LG	85666	Centre Lid Only Light Grey	3m



# SLSR

The SLSR 50x170mm is designed for a broad range of installations including public sector, education and health, as well as commercial and industrial environments.

Also available in pre-assembled units, saving time and money on installation. Ideal for student accommodation or modular build.

### Product information

- 170x50mm curved top/square bottom
- High impact resistant
- Will accept our new adjustable Single and Twin Back Boxes (SLB1-A and SLB2-A)
- DDA compliance with Light Grey centre lid option

Material

PVC-U



flame retardant



-25 °C/+60 °C



2J

## SLSR



Part No.	A-Code	Description	Pk Qty
SLSR 50/170	108522	Skirting Trunking	3m

## Fittings

Internal Angle



Part No.	A-Code	Description	Pk Qty
SRIE 50/170	108524	Internal Angle Skirting	1pc

External Angle



Part No.	A-Code	Description	Pk Qty
SRAE 50/170	108523	External Bend Skirting	1pc

Fittings *continued*

Flat Angles Upwards		<b>Part No.</b> SRFWU 50/170	<b>A-Code</b> 108525	<b>Description</b> Flat Bend Upward Skirting	<b>Pk Qty</b> 1pc
Flat Angles Downwards		<b>Part No.</b> SRFWD 50/170	<b>A-Code</b> 108526	<b>Description</b> Flat Bend Downward Skirting	<b>Pk Qty</b> 1pc
Flat Tees Upwards		<b>Part No.</b> SRFTU 50/170	<b>A-Code</b> 108528	<b>Description</b> Flat Tee Upward Skirting	<b>Pk Qty</b> 1pc
Flat Tees Downwards		<b>Part No.</b> SRFTD 50/170	<b>A-Code</b> 108529	<b>Description</b> Flat Tee Downward Skirting	<b>Pk Qty</b> 1pc
Coupler		<b>Part No.</b> SRK 50/170	<b>A-Code</b> 108527	<b>Description</b> Coupler Skirting	<b>Pk Qty</b> 1pc
End Caps		<b>Part No.</b> SREL 50/170 SRER 50/170	<b>A-Code</b> 108530 108531	<b>Description</b> Left Hand End Cap Skirting Right Hand End Cap Skirting	<b>Pk Qty</b> 1pc 1pc
Back Boxes		<b>Part No.</b> SLB1-A SLB2-A	<b>A-Code</b> 104560 104561	<b>Description</b> Adjustable Single box 30mm-50mm Adjustable Twin box 30mm-50mm	<b>Pk Qty</b> 1pc 1pc
Spare Lid		<b>Part No.</b> SLR42/50 SL80 SL80 LG SLQN42/50	<b>A-Code</b> 101429 82106 85666 107283	<b>Description</b> Curved Lid (1x3m) Centre Lid (2x3m) Centre Lid Only Light Grey Square Lid (1x3m)	<b>Pk Qty</b> 3m 6m 3m 3m



# SLQN

SLQN 50x170mm is designed for a broad range of installations including public sector, education and health, as well as commercial and industrial environments.

Also available in pre-assembled units, saving time and money on installation and is ideal for student accommodation or modular build.

### Product information

- 170x50mm square/square
- High impact resistant
- Will accept our new adjustable Single and Twin Back Boxes (SLB1-A and SLB2-A)
- DDA compliance with Light Grey centre lid option

Material  
PVC-U



flame retardant



-25 °C/+60 °C



2J

## SLQN



Part No.	A-Code	Description	Pk Qty
SLQN 50/170	107281	Dado Trunking Square	3m

## Fittings

Internal Angle



Part No.	A-Code	Description	Pk Qty
QIEN 50/170	107287	Internal Angle Dado Square	1pc

External Angle





Part No.	A-Code	Description	Pk Qty
QAEN 50/170	107288	External Angles Dado Square	1pc

Fittings *continued*

Flat Angles		Part No.	A-Code	Description	Pk Qty
		QFWN 50/170	107285	Flat Angles Dado Square	1pc

Flat Tees		Part No.	A-Code	Description	Pk Qty
		QFTN 50/170	107284	Flat Tees Dado Square	1pc

Coupler		Part No.	A-Code	Description	Pk Qty
		QKN 50/170	107289	Coupler Dado Square	1pc

End Caps		Part No.	A-Code	Description	Pk Qty
		QE 50/170	36073	End Cap Dado Square	1pc

Back Boxes		Part No.	A-Code	Description	Pk Qty
		SLB1-A	104560	Adjustable Single box 30mm-50mm	1pc
		SLB2-A	104561	Adjustable Twin box 30mm-50mm	1pc

Spare Lid		Part No.	A-Code	Description	Pk Qty
		SLQN42/50	107283	Square Lid (1x3m)	3m
		SL80	82106	Centre Lid (2x3m)	6m
		SL80 LG	85666	Centre Lid Only Light Grey	3m



# Bench Trunking

Univolt's Bench Trunking is manufactured in a high impact White PVC finish and is ideal for containing both power and data cables within laboratory, school and office environments.

Bench Trunking comes in a three-metre length as standard, with the option to mount the product back-to-back. It is also angled and suitable for desks, benches, or worktop applications.

Additional Clip-on Dividers (Univolt MTW50) can be installed to segregate power and data cabling. A full range of fabricated fittings are also available when utilising Univolt's new adjustable Single or Twin Back Boxes for power and data sockets.

Single and twin Bench Pods comes complete with Back Boxes. Bespoke units are also available.

### Product information

- Clip on divider available to segregate power and data cables
- New Single and Twin adjustable Back Boxes (30mm – 50mm) can be fitted for power and data sockets
- 100mm x 100mm



## Bench Trunking

Part No.	A-Code	Description	Pk Qty
BT	104066	100x100mm PVC Bench Trunking c/w White Lid - 3m Length	3m
BT-LGL	-	100x100mm PVC Bench Trunking c/w Light Grey Centre Lid - 3m Length	3m

## Fittings

1 Gang bench box single sided / double sided



Part No.	A-Code	Description	Pk Qty
BT-1G	104071	1 Gang Bench Box	1pc
BT-1GD	104072	1 Gang Bench Box Double Sided	1pc

2 Gang bench box single sided / double sided



Part No.	A-Code	Description	Pk Qty
BT-2G	104073	2 Gang Bench Box	1pc
BT-2GD	104074	2 Gang Bench Box Double Sided	1pc

Fittings *continued*

3 Gang bench box single sided / double sided		<b>Part No.</b>	<b>A-Code</b>	<b>Description</b>	<b>Pk Qty</b>
		BT1+2G	104075	3 Gang Bench Box	1pc
		BT1+2GD	104076	3 Gang Bench Box Double Sided	1pc
Internal Angle		<b>Part No.</b>	<b>A-Code</b>	<b>Description</b>	<b>Pk Qty</b>
		BT-IB	104077	Internal Angle	1pc
External Angle		<b>Part No.</b>	<b>A-Code</b>	<b>Description</b>	<b>Pk Qty</b>
		BT-EB	104078	External Angle	1pc
Coupler		<b>Part No.</b>	<b>A-Code</b>	<b>Description</b>	<b>Pk Qty</b>
		BT/BC	104070	Coupler	1pc
Endcap		<b>Part No.</b>	<b>A-Code</b>	<b>Description</b>	<b>Pk Qty</b>
		BT/BES	104068	End Cap	1pc
		BT/BED	104069	Double End Cap	1pc
Divider		<b>Part No.</b>	<b>A-Code</b>	<b>Description</b>	<b>Pk Qty</b>
		MTW 50	19717	Divider	3m
Back Boxes		<b>Part No.</b>	<b>A-Code</b>	<b>Description</b>	<b>Pk Qty</b>
		SLB1-A	104560	Adjustable Single box 30mm-50mm	1pc
		SLB2-A	104561	Adjustable Twin box 30mm-50mm	1pc



# Aluminium Power Pole

Univolt's Power Poles are a great addition to any workspace, providing the perfect space-saving cable management solution.

At 3.5m, the Power Pole comes with six Accessory Boxes and is powder coated White, making it easy to clean and maintain, offering a bright and attractive finish.

### Product information

- New telescopic arm fixing for fast installation
- Can be extended with a 2.5m extension arm
- Modern design
- New design fixing for base
- Powder coated White (RAL9010)

## Aluminium Power Pole



### Part No.

PP2WT

### A-Code

105886

### Description

Power Pole 3.5m (Aluminum White)  
c/w 6x SLB1

### Pk Qty

1pc

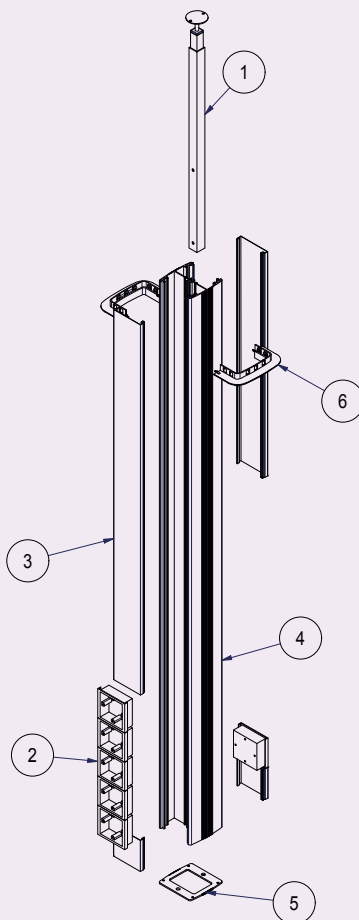

### KEY DESIGN FEATURES

New telescopic adjustable arm fixing for fast installation.

PP2WT (powder coated White) - 3.5m long, extendable up to 3.95m

More modern design

c/w 6 x 1 gang boxes (SLB1) including roof collar.

New design fixing for base

New design fixing for ceiling

Colours – Powder coated White (RAL9010).

Additional extra 2.5m extension kit (PP2EXT), enabling the power pole to be extended to a total of 6m

### Item

### Description

- |   |                                 |
|---|---------------------------------|
| 1 | Adjustable Fixing Arm 100-400mm |
| 2 | Single Outlet Box               |
| 3 | PVC Lid                         |
| 4 | Power Pole - 3.5M               |
| 5 | Floor Fixing Plate              |
| 6 | Ceiling Tile Collar             |

# Fittings

Centre Lid		Part No.	A-Code	Description	Pk Qty
		SL 80	82106	Spare Centre Lid (2x3m)	6m

Divider		Part No.	A-Code	Description	Pk Qty
		MTW50	19717	Divider (1x3m)	3m

Gang Boxes		Part No.	A-Code	Description	Pk Qty
		SLB 1	36075	1 Gang Box	1pc
		SLB 2	36076	2 Gang Box	1pc

Extension Kit		Part No.	A-Code	Description	Pk Qty
		PP2EXT	105891	PP2 2.5m Extension Kit	1 pc

Ceiling Collar		Part No.	A-Code	Description	Pk Qty
		PP2CC	105890	PP2 Ceiling Collar	1 pc





**\*NEW\***

# Bespoke Power Pole

Bespoke and specialised Power Poles

Univolt offers a bespoke design solution for Power Poles, with various heights available and a high density of boxes.

**Available in:**

- Natural anodized aluminium
- Powder coated White, RAL 9010
- Will accept a high density of 45x45mm mosaic power and data sockets
- Round or square finishes available

Univolt's most flexible Power Pole solution made to measure.



## Single Free-Standing Power Pole

- Will support a large amount of power and data sockets (45x45mm mosaic sockets only)
- 3.5m as standard, however, use of a ceiling bracket can reach greater height
- Often used in open plan office space where there are frequent changes in layouts
- Cost and time-saving solution when compared to fixed installations

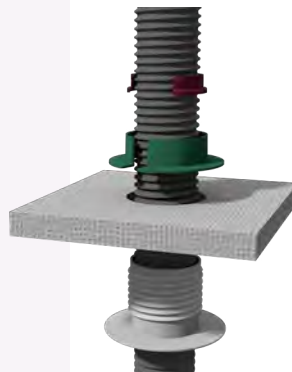
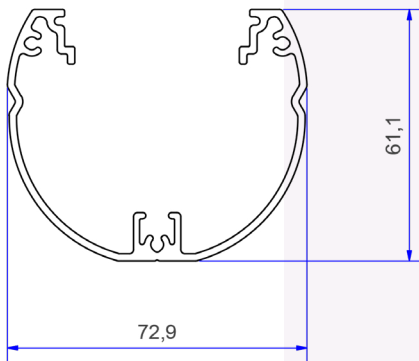

■ Natural anodized aluminum   ■ White, RAL 9010   ■ Black, RAL 9005

## 4-Way Free-Standing Power Pole

- This unique Power Pole has the flexibility to take high density power and data sockets (24 mosaic 45x45mm power, or data sockets can be installed in the bottom section)
- 3.5m as standard, however, a flexible hose and ceiling bracket can be used to achieve greater heights
- Often used in open plan office space where there are frequent changes in layouts
- Cost and time-saving solution when compared to fixed installations

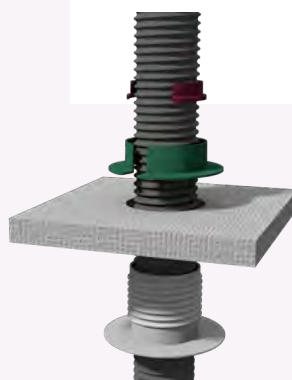
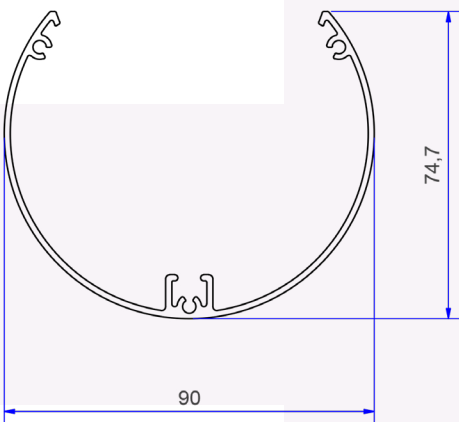

■ Natural anodized aluminum   ■ White, RAL 9010



## Single Floor-to-Ceiling Fixed Power Pole

- Single floor-to-ceiling fixed Power Pole
- Telescopic arm for fast fix installation
- Will accommodate a large amount of power and data sockets (45x45mm mosaic sockets only)
- Often used in open plan office environments

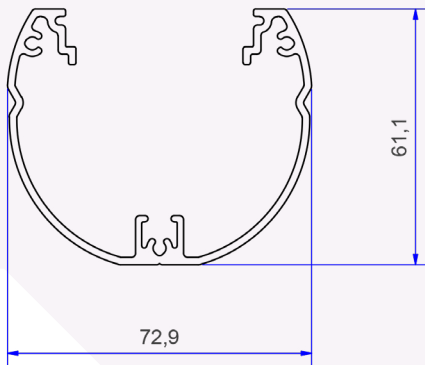

- Natural anodized aluminum
- White, RAL 9010
- Black, RAL 9005

## Double Floor-to-Ceiling Fixed Power Pole

- Telescopic arm for fast fix installation
- Will accommodate a large amount of power and data sockets (45x45mm mosaic sockets only)
- Often used in open plan office spaces
- 3.5m as standard, although can be manufactured to other lengths
- Comes with ceiling collar

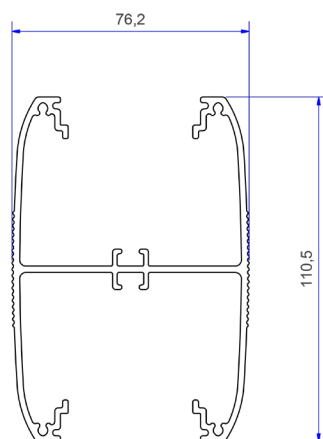

- Natural anodized aluminum
- White, RAL 9010



## Single Wall-Mounted Power Pole

- Ideal for use against the wall, both vertically, or horizontally
- Will accommodate a large amount of power and data sockets (45x45mm mosaic sockets only)
- Quick installation using snap-on wall brackets
- Cost-effective solution compared to wall channels
- Comes with ceiling collar

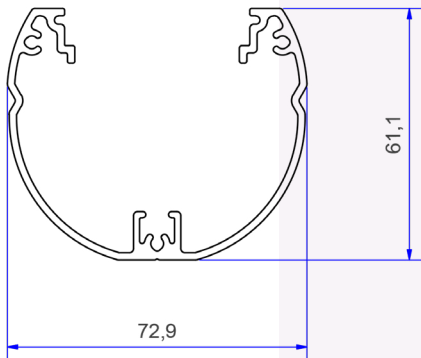

- Natural anodized aluminum
- White, RAL 9010
- Black, RAL 9005

## Ceiling to Floor raceway

- Can be installed as free standing, or a fixed installation
- Ideal for cable feed to desk management modules
- The satellite solution is used in areas where flexibility and quick changes are required

- Natural anodized aluminum
- White, RAL 9010
- Black, RAL 9005

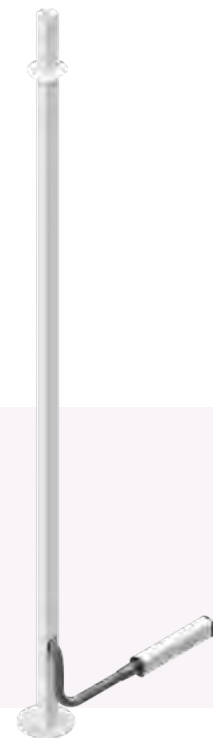
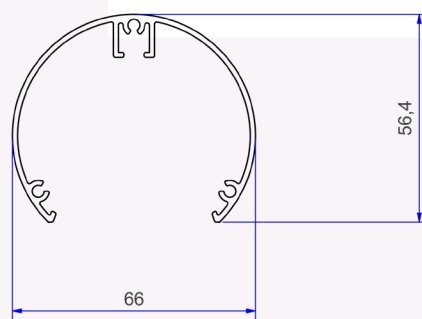
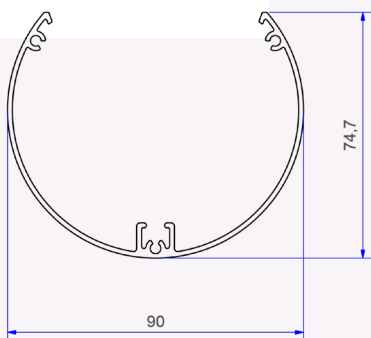

# Cavity Floor Boxes

The three-compartment Cavity Floor Box provides a flexible under floor cable management solution, meeting the requirements of almost any commercial or public environment.

The Cavity Floor Box is manufactured from pre-galvanised sheet steel in accordance with BS EN10142 and comes complete with two Quick Lock fixings, enabling a safe and speedy installation by clamping the base unit to the underside of the floor.

The Floor Box comes with three plates fitted as standard, accommodating any standard twin White power socket and data plate. The box includes both a 20mm and 25mm knockout for rigid or flexible conduits.

### Product information

- Three-compartment Cavity Floor Box as standard (quick-fit design for ease of installation)
- 85mm deep for CAT 5, CAT6 and CAT6A
- Will accept any manufacturers standard White twin sockets and twin data plates
- 20mm and 25mm knockouts to accept rigid or flexible conduits
- Supporting accessories also available
- Max flooring thickness 8mm

## Cavity Floor Box



Part No.	A-Code	Description	Pk Qty
SAB3/85	109725	3 Comp Cavity Floor Box - 85mm Deep C/W 3 x 2 Gang accessory Plate, to accept standard White double power sockets	1pc

## Dimensions

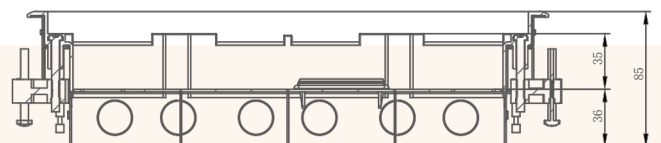
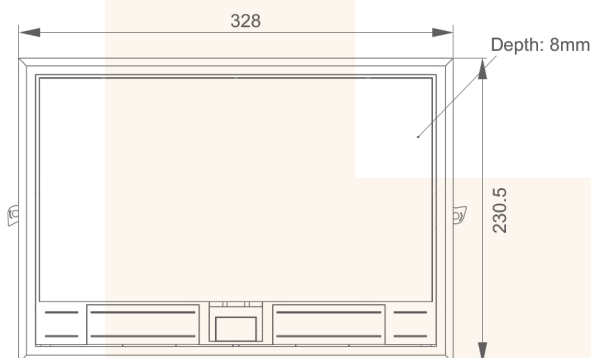

Cut out dimension 313x128mm

# Screeded Floor Box

The Univolt Screeded three compartment Floor Box supports the distribution of power and data cables in screeded floor installations.

The Floor Box is manufactured from pre-galvanised sheet steel in accordance with BS EN10142.

The Floor Box comes empty as standard and can be fitted with Univolt's range of accessories.

The box includes both a 20mm and 25mm knockout for rigid or flexible conduits.

## Product information

- Three-compartment Floor Box as standard- 85mm deep
- CAT 5e, CAT6 and CAT6A compatible
- Will accept Univolt's range of plate accessories (page 58)
- 20mm and 25mm knockouts to accept rigid or flexible conduits
- Max flooring thickness 8mm

## Screeded Floor box



Part No.	A-Code	Description	Pk Qty
SAS3/85	110141	3 Comp empty screed floor box-85mm deep. Will accept all floor plate accessories (page 58)	1pc



## Dimensions

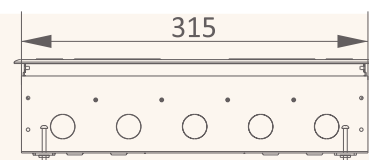
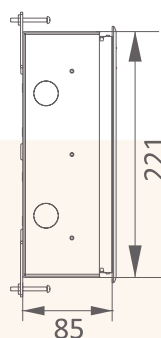
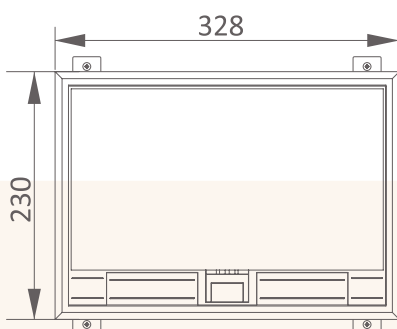

## Cavity & Screeded Floor Box Fittings

Twin Switch Socket Plate

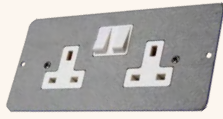

Part No.	A-Code	Description	Pk Qty
SAB305	109726	Twin Switch Socket Plate	1pc

Twin Accessory Plate

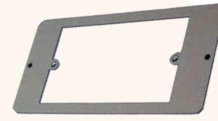

Part No.	A-Code	Description	Pk Qty
SAB303	109730	Twin Accessory Plate	1pc

Blank Plate



Part No.	A-Code	Description	Pk Qty
SAB300	109727	Blank Plate	1pc

4 x LJ6C Plate



Part No.	A-Code	Description	Pk Qty
SAB307	109729	4 x LJ6C Plate (37x22mm cut out)	1pc

2 x 1 Gang Plate



Part No.	A-Code	Description	Pk Qty
SAB310	109731	2 x 1 Gang Plate	1pc

Euro Mod Plate



Part No.	A-Code	Description	Pk Qty
SAB312	109728	Euro Mod Plate 50x50mm	1pc

## Key Features for Cavity & Screeded Floor Box



### Recessed Lid To Suit your Floor Covering:

Aesthetic cover features a recess to accept floor covering to match the surrounding floor, providing a smooth, seamless look.

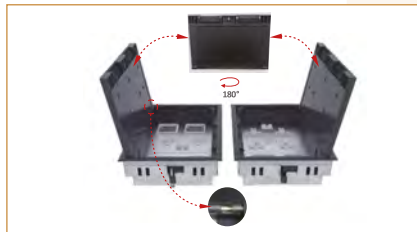

### Removable And Reversible Lid:

The lid can be rotated without the use of tools for easy outgoing cables orientation.



### Low Profile bevelled Flange:

Cover top features low profile bevelled flange to prevent tripping hazards.



Galvanized Steel Support

### Durable Galvanized Steel Housing:

The base box construction, including the lid support plate, is made from galvanized steel, which delivers added strength and reliability.



Cable

### Retaining Cable Guard:

Protects cables and reduces risk of damage to all incoming and outgoing cables.



### Easy grip recessed lifting handle:

Equipped with recessed flip-up handle to facilitate the access to box services.

# Waterproof Floor Box

The new Univolt Waterproof Floor Box range (IP66 & IP65) is ideal for either cavity, or screeded floors, providing complete protection from water and humidity.

Available in either a stainless steel or zinc alloy finish, the Waterproof Floor Box offers the perfect containment solution for open spaces affected by heavy workflow. The floor boxes, when closed, can be easily cleaned due to their IP rating.

Combining durability with sleek aesthetics, this unit offers versatility and functionality for almost any project.

## Waterproof Floor box - Square IP66



Image for illustration purposes only.

Part No.	A-Code	Description	Pk Qty
SOB-3SCS	110137	1 Com Square IP66 Floor Box - Cavity or Screeded Floor (Stainless Steel)	1pc

### Key features:

- Can be used for either cavity, or screeded floor
- IP66 waterproof floor box
- Square stainless steel plate
- Comes with one 13 amp socket with neon switch and two USB-C ports (complete)
- Cable protector when in use.

### Dimensions:

- Cutout – 120x135mm
- Product size – 143x173mm

## Waterproof Floor box - Round IP65



Image for illustration purposes only.

Part No.	A-Code	Description	Pk Qty
OB-4SCS	110139	1 Com Round IP65 Floor Box - Cavity or Screeded Floor (Zinc Alloy)	1pc

### Key features:

- Can be used for either cavity, or screeded floor
- IP65 waterproof floor box
- Circular zinc alloy steel plate
- Comes with one 13 amp socket with neon switch and two USB-C ports (complete)
- Cable protector when in use

### Dimensions:

- Cutout – Ø130 mm
- Product size – Ø150 mm



# Thermoplastic (PVC) Cable Tray

Insulating Perforated Thermoplastic Cable Trays - for support, protection and conduction of cables.

Univolt's Thermoplastic PVC Cable Tray (in partnership with Unex) is a market leading product, ideal for indoor and outdoor installation with its insulating material, making it resistant to corrosion and chemical agents offering excellent performance with exposure to UV rays.

**Unex Group**, with a history spanning some 60 years, is a leading global manufacturer of innovative Thermoplastic Cable Management Systems. These systems are designed for a variety of sectors including electrical, telecommunications, and HVAC installations.



## U23X Cable Tray Lengths 60mm Depth



Part No.	A-Code	Description	Pk Qty
66100	107651	Perforated cable tray Light Grey 60x100mm U23X	8 Lengths
66150	107793	Perforated cable tray Light Grey 60x150mm U23X	4 Lengths
66200	107652	Perforated cable tray Light Grey 60x200mm U23X	4 Lengths
66300	107653	Perforated cable tray Light Grey 60x300mm U23X	4 Lengths

## U23X Cable Tray Lengths 100mm Depth

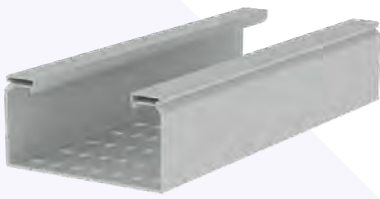

Part No.	A-Code	Description	Pk Qty
66220	107794	Perforated cable tray Light Grey 100x200mm U23X	2 Lengths
66320	107795	Perforated cable tray Light Grey 100x300mm U23X	2 Lengths
66420	107796	Perforated cable tray Light Grey 100x400mm U23X	2 Lengths
66620	107797	Perforated cable tray Light Grey 100x600mm U23X	2 Lengths

**Advantages and benefits**

- Insulating material offering maximum electrical safety: protection against indirect contacts.
- Robust and durable system offering increased rigidity and mounting security.
- Easy to cut on site (no hot works), no deburring, or galvafruid needed.
- Maintenance free: reduces installation time and costs, with no earthing required.
- Excellent resistance to corrosion caused by direct exposure to humid, saline or chemically aggressive environments.
- Suitable for outdoor use. Excellent performance even under the most demanding weather conditions including temperature changes, solar radiation, etc. (excellent UV properties).
- High mechanical and impact resistance.
- Designed to work at full load: simpler calculation process in the design of the cable tray, execution and control of the installation. Load resistance in future extensions of the installation.





## Fittings

### Cable Tray Covers

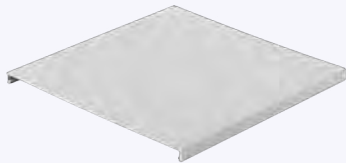

Part No.	A-Code	Description	Pk Qty
66102	107798	Cover Light Grey 100mm U23X	1 Length
66152	107799	Cover Light Grey 150mm U23X	1 Length
66202	107800	Cover Light Grey 200mm U23X	1 Length
66302	107801	Cover Light Grey 300mm U23X	1 Length
66402	107802	Cover Light Grey 400mm U23X	1 Length
66602	107803	Cover Light Grey 600mm U23X	1 Length

### Joint couplers and accessories to make bends



Part No.	A-Code	Description	Pk Qty
66825	107817	Joint coupler Light Grey 60mm U23X	1pc
66835	107818	Joint coupler grey RAL7035 100mm U23X	1pc
66813	107819	Vertical hinge Light Grey 60mm U23X	1pc
66833	107820	Vertical hinge Light Grey 100mm U23X	1pc
66844	107835	Horizontal hinge Light Grey 60mm U24X Horizontal hinges can do all the angle between +/- 90°	1pc
66854	107836	Horizontal hinge Light Grey 100mm U24X Horizontal hinges can do all the angle between +/- 90°	1pc
66809	107816	Bolt DIN 603 and nut Light Grey M8x22mm U23X	100pcs

Unex product portfolio includes Thermoplastic Cable Trays suitable for both indoor and harsh outdoor environments. These products are engineered to resist corrosion and are well-suited for areas with prolonged exposure to UV rays, while maintaining their mechanical capacity. The technical characteristics of these products, exceeding market standards, are attributed to Unex's own formulation and design of raw materials and products.

### Flat Radius Bend



Part No.	A-Code	Description	Pk Qty
66110	107821	Flat radius bend Light Grey 60x100mm U23X	1pc
66160	107822	Flat radius bend Light Grey 60x150mm U23X	1pc
66210	107823	Flat radius bend Light Grey 60x200mm U23X	1pc
66310	107824	Flat radius bend Light Grey 60x300mm U23X	1pc
66230	107825	Flat radius bend Light Grey 100x200mm U23X	1pc
66330	107826	Flat radius bend Light Grey 100x300mm U23X	1pc
66430	107827	Flat radius bend Light Grey 100x400mm U23X	1pc
66630	107828	Flat radius bend Light Grey 100x600mm U23X	1pc

### Flat Bend Covers



Part No.	A-Code	Description	Pk Qty
66111	107829	Flat bend cover Light Grey 100mm U23X	1pc
66161	107830	Flat bend cover Light Grey 150mm U23X	1pc
66211	107831	Flat bend cover Light Grey 200mm U23X	1pc
66311	107832	Flat bend cover Light Grey 300mm U23X	1pc
66411	107833	Flat bend cover Light Grey 400mm U23X	1pc
66611	107834	Flat bend cover Light Grey 600mm U23X	1pc

Fittings *continued*

Radius Tees

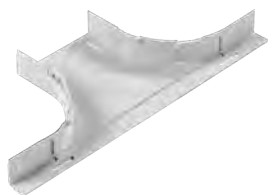

Part No.	A-Code	Description	Pk Qty
66128	108475	Radius Tee Light Grey 60x100mm U23X	1pc
66178	108476	Radius Tee Light Grey 60x150mm U23X	1pc
66228	108477	Radius Tee Light Grey 60x200mm U23X	1pc
66328	108478	Radius Tee Light Grey 60x300mm U23X	1pc
66248	108823	Radius Tee Light Grey 100x200mm U23X	1pc
66348	108824	Radius Tee Light Grey 100x300mm U23X	1pc
66448	108825	Radius Tee Light Grey 100x400mm U23X	1pc
66648	108826	Radius Tee Light Grey 100x600mm U23X	1pc

Radius Tee Covers



Part No.	A-Code	Description	Pk Qty
66129	109660	68 Semi Tee cover Light Grey 100mm U23X	1pc
66179	109661	66 Semi Tee cover Light Grey 150mm U23X	1pc
66229	109663	66 Semi Tee cover Light Grey 200mm U23X	1pc
66329	109545	66 Semi Tee cover Light Grey 300mm U23X	1pc
66429	109765	66 Semi Tee cover Light Grey 400mm U23X	1pc
66629	109766	66 Semi Tee cover Light Grey 600mm U23X	1pc



End Covers

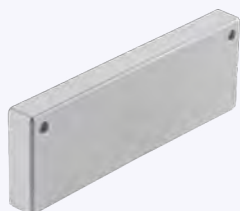

Part No.	A-Code	Description	Pk Qty
66113	107837	End cover Light Grey 60x100mm U23X	1pc
66163	107838	End cover Light Grey 60x150mm U23X	1pc
66213	107839	End cover Light Grey 60x200mm U23X	1pc
66313	107840	End cover Light Grey 60x300mm U23X	1pc
66233	107841	End cover Light Grey 100x200mm U23X	1pc
66333	107842	End cover Light Grey 100x300mm U23X	1pc
66433	107843	End cover Light Grey 100x400mm U23X	1pc
66633	107844	End cover Light Grey 100x600mm U23X	1pc



## Fittings *continued*

### Wall Supports

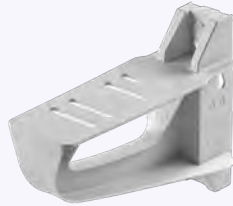

Part No.	A-Code	Description	Pk Qty
60103-44	107804	Insulating horizontal support Light Grey 100mm U48X	1pc
60153-44	107805	Insulating horizontal support Light Grey 150mm U48X	1pc
60203-44	107806	Insulating horizontal support Light Grey 200mm U48X	1pc
60303-44	107807	Insulating horizontal support Light Grey 300mm U48X	1pc
60403-44	107808	Insulating horizontal support Light Grey 400mm U48X	1pc
60603-44	107809	Insulating horizontal support Light Grey 600mm U48X	1pc

### Base Supports



Part No.	A-Code	Description	Pk Qty
66075	107810	Insulating vertical support Light Grey 75mm U23X	1pc
66155	107811	Insulating vertical support Light Grey 150mm U23X	1pc
66205	107812	Insulating vertical support Light Grey 200mm U23X	1pc
66305	107813	Insulating vertical support Light Grey 300mm U23X	1pc
66405	107814	Insulating vertical support Light Grey 400mm U23X	1pc
66605	107815	Insulating vertical support Light Grey 600mm U23X	1pc

### Divider

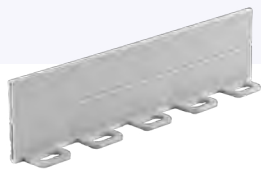

Part No.	A-Code	Description	Pk Qty
66821	107845	Divider Light Grey 60mm U23X	1 Length
66831	107846	Divider Light Grey 100mm U23X	1 Length



### Ideal for use within the following environments:

- Chemical plants
- Leisure centres
- Water treatment works
- Coastal spaces
- Solar
- Tunnels

GRP & Thermoplastic Strut

Thermoplastic Strut (2m)  
Halogen Free

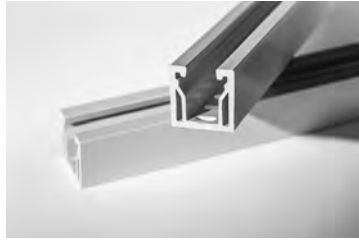

Part No.	A-Code	Description	Pk Qty
60202-48	108392	Strut channel Grey 25x50x2000mm Halogen Free	1 Length
60204-48	108393	Strut channel Grey 50x50x2000mm Halogen Free	1 Length

GRP Strut Slotted (3M)



Part No.	A-Code	Description	Pk Qty
UGRP4125	108404	GRP Slotted Strut 41x25x3000mm	1 Length
UGRP4141	108403	GRP Slotted Strut 41x41x3000mm	1 Length





# FlexX Steel

FlexX Steel Conduit is a flexible metallic Conduit (FMC) often used in electrical installations. It's known for combining the strength of steel with the flexibility needed for complex routing.

Here are the key benefits:

### Flexibility

- Easily bends to accommodate tight or complex spaces.
- Reduces the need for additional fittings or elbows.
- Ideal for commercial refurbishments.

### Strength & Durability

- Made of steel for enhanced mechanical protection.
- Resists physical damage better than non-metallic Conduits.
- Withstands harsh environmental conditions when properly installed.

### EMI Shielding

- Metal construction offers natural electromagnetic interference (EMI) shielding.
- Protects sensitive electrical equipment and data cables.

### Fire Resistance

- Steel is non-combustible and does not emit toxic fumes when exposed to fire.
- Often compliant with fire safety regulations in commercial settings.

### Easy Installation

- Can be cut with standard tools and installed without heavy equipment.
- Threads easily into connectors, saving time on the job site.

### Versatile Applications

- Common in commercial buildings, industrial plants, and even some residential installations.
- Can be used in dry, damp, or even hazardous environments with the correct fittings.

## FlexX Steel 20mm Bare



Part No.	A-Code	Description	Pk Qty
HX-UNB20/10	109835	Coil 20mm Bare	10m
HX-UNB20/25	109837	Coil 20mm Bare	25m
HX-UNB20/50	109838	Coil 20mm Bare	50m

## FlexX Steel 25mm Bare



Part No.	A-Code	Description	Pk Qty
HX-UNB25/10	109839	Coil 25mm Bare	10m
HX-UNB25/25	109840	Coil 25mm Bare	25m
HX-UNB25/50	109841	Coil 25mm Bare	50m

## FlexX Steel 20mm PVC Coated Black



Part No.	A-Code	Description	Pk Qty
HX-UNP20/10	109842	Coil 20mm PVC ( RoHS 2.0 ) Coated Black	10m
HX-UNP20/25	109843	Coil 20mm PVC ( RoHS 2.0 ) Coated Black	25m
HX-UNP20/50	109844	Coil 20mm PVC ( RoHS 2.0 ) Coated Black	50m

## FlexX Steel 25mm PVC Coated Black



Part No.	A-Code	Description	Pk Qty
HX-UNP25/10	109845	Coil 25mm PVC ( RoHS 2.0 ) Coated Black	10m
HX-UNP25/25	109846	Coil 25mm PVC ( RoHS 2.0 ) Coated Black	25m
HX-UNP25/50	109847	Coil 25mm PVC ( RoHS 2.0 ) Coated Black	50m

## FlexX Steel 20mm LSFOH Coated Black



Part No.	A-Code	Description	Pk Qty
HX-UNOH20/10	109848	Coil 20mm LSFOH Coated Black	10m
HX-UNOH20/25	109849	Coil 20mm LSFOH Coated Black	25m
HX-UNOH20/50	109850	Coil 20mm LSFOH Coated Black	50m

## FlexX Steel 25mm LSFOH Coated Black



Part No.	A-Code	Description	Pk Qty
HX-UNOH25/10	109851	Coil 25mm LSFOH Coated Black	10m
HX-UNOH25/25	109852	Coil 25mm LSFOH Coated Black	25m
HX-UNOH25/50	109853	Coil 25mm LSFOH Coated Black	50m



Contractor pack 20mm and 25mm PVC coated Black- IP54



Part No.	A-Code	Description	Pk Qty
HX-UNP/20CON/10	109854	Contractor Pack c/w 10 Swivel Glands PVC coated	10m
HX-UNP/25CON/10	109857	Contractor Pack c/w 10 Swivel Glands PVC coated	10m

Contractor Pack 20mm and 25mm Bare - IP40



Part No.	A-Code	Description	Pk Qty
HX-UNB/25CON/10	109858	Contractor Pack c/w 10 Swivel Glands Bare	10m
HX-UNB/20CON/10	109855	Contractor Pack c/w 10 Swivel Glands Bare	10m

## Fittings

Swivel Glands  
(Nickel Plated Brass)

Part No.	A-Code	Description	Pk Qty
HX-RG-UNS20	109860	Swivel (Nickel Plated Brass Gland)	10pcs
HX-RG-UNS25	109861	Swivel (Nickel Plated Brass Gland)	10pcs

Fixed Glands (Nickel  
Plated Brass)

Part No.	A-Code	Description	Pk Qty
HX-RG-UNF20	109862	Fixed (Nickel Plated Brass Gland)	10pcs
HX-RG-UNF25	109863	Fixed (Nickel Plated Brass Gland)	10pcs

**NB: Fixed gland rated at IP65 / Swivel gland is IP40 for bare conduit and IP54 for PVC coated.**

**Temperature Range Bare:**

- 100°C to +300°C

**Temperature Range PVC coated:**

-15°C to +70°C





# PVC Flexible Conduit

Univolt's Flexible Conduit is available in either PVC or LSFOH, with a light or medium gauge option and in a Black, White, Grey or Orange finish. Available from a 12mm diameter up to 63mm diameter, in coils of 25m or 50m.

## Medium Gauge (750N) PVC-u (UV Stabilised)



Ideal for Solar Installations



Part No.	A-Code	Description	Pk Qty
FXP 16 B	98772	16mm Medium Gauge Black	50m
FXP 20 B	84057	20mm Medium Gauge Black	50m
FXP 25 B	84058	25mm Medium Gauge Black	50m
FXP 32 B	98773	32mm Medium Gauge Black	25m
FXP 40 B	98774	40mm Medium Gauge Black	25m
FXP 50 B	98775	50mm Medium Gauge Black	25m
FXP 63 B	98776	63mm Medium Gauge Black	25m

FXP  
Turbo bk

DIETZEL  
UNIVOLT  
full of energy.

UV-stable  
up to 10 years

Fittings

Flexible Conduit Grip Style Coupler



Part No.	A-Code	Description	Pk Qty
KM 20 LG	83837	Conduit Grip Coupler 20mm Light Grey	100pcs
KM 20 BK	84051	Conduit Grip Coupler 20mm Black	100pcs
KM 20 O	80642	Conduit Grip Coupler 20mm Orange	100pcs
KM 25 LG	83839	Conduit Grip Coupler 25mm Light Grey	50pcs
KM 25BK	84052	Conduit Grip Coupler 25mm Black	50pcs
KM 25 O	80643	Conduit Grip Coupler 25mm Orange	50pcs
KM 32 LG	85924	Conduit Grip Coupler 32mm Light Grey	25pcs
KM 32 BK	85926	Conduit Grip Coupler 32mm Black	25pcs
KM 32 O	85925	Conduit Grip Coupler 32mm Orange	25pcs

Flexible Conduit Fittings



Part No.	A-Code	Description	Pk Qty
SGL 16/16 G	12699	Glands 16mm Grey IP54	100pcs
SGL 16/16 B	27798	Glands 16mm Black IP54	100pcs
SGL 20/20 G	12700	Glands 20mm Grey IP54	50pcs
SGL 20/20 B	27799	Glands 20mm Black IP54	50pcs
SGL 25/25 G	12701	Glands 25mm Grey IP54	50pcs
SGL 25/25 B	27800	Glands 25mm Black IP54	50pcs
SGL 32/32 G	12702	Glands 32mm Grey IP54	30pcs
SGL 32/32 B	27801	Glands 32mm Black IP54	30pcs
SGL 40/40 G	15509	Glands 40mm Grey IP54	20pcs
SGL 40/40 B	27802	Glands 40mm Black IP54	20pcs
SGL 50/50 G	15508	Glands 50mm Grey IP54	16pcs
SGL 50/50 B	27803	Glands 50mm Black IP54	16pcs
SGL 63/63 G	43075	Glands 63mm Grey IP54	6pcs
SGL 63/63 B	27804	Glands 63mm Black IP54	6pcs

Flexible Conduit Clips

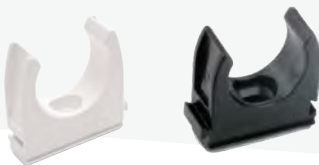

Part No.	A-Code	Description	Pk Qty
CL 20 BK	82179	20mm Clips Black	100pcs
CL 20 LG	82178	20mm Clips Light Grey	100pcs
CL 25 BK	82216	25mm Clips Black	100pcs
CL 25 LG	82215	25mm Clips Light Grey	100pcs
CL 32 LG	82219	32mm Clips Light Grey	50pcs
CL 32 BK	82220	32mm Clips Black	50pcs

**10 Year Product Warranty**

Dietzel-Univolt warrants that FXPS-UV conduit will not suffer from significant mechanical deterioration from ultra violet light exposure for a period of up to 10 years from the purchase date of the product, where significant degradation of the conduits mechanical properties has been caused by ultra violet radiation Dietzel-Univolt will replace the conduit free of charge, the owner of the solar facility must be able to prove the conduit was installed correctly and regularly inspected and maintained.

**Warranty Exclusions**

Dietzel-Univolt does not cover deterioration of flexible conduit due to any of the following circumstances:- Incorrect conduit selected for application and environment. - Incorrect installation of flexible conduit. - Failure to follow Dietzel-Univolt's selection and installation guidance. - Flexible conduit damage or deterioration other than by UV radiation.

Limited Liability: Dietzel-Univolt's liability is strictly limited to the supply of replacement conduit only.

For more detailed information concerning our products including technical data and standards we kindly ask you to contact our Export Department.

Any reproduction of this catalogue, partly or in whole, is only permitted with the written consent of Dietzel GmbH. Errors and omissions excepted.



# Light Gauge Flexible – Various Coil Sizes

## Light Gauge Black (320N) PVC-u



Part No.	A-Code	Description	Pk Qty
FX 20 BK 25M	109607	20mm Light Gauge Flexible Conduit Black	25m
FX 20 BK 50M	109608	20mm Light Gauge Flexible Conduit Black	50m
FX 20 BK 100M	109609	20mm Light Gauge Flexible Conduit Black	100m
FX 25 BK 25M	109610	25mm Light Gauge Flexible Conduit Black	25m
FX 25 BK 50M	109612	25mm Light Gauge Flexible Conduit Black	50m
FX 25 BK 100M	109614	25mm Light Gauge Flexible Conduit Black	100m
FX 32 BK 25M	109618	32mm Light Gauge Flexible Conduit Black	25m
FX 50 BK 25M	109619	50mm Light Gauge Flexible Conduit Black	25m

## Light Gauge White (320N) PVC-u



Part No.	A-Code	Description	Pk Qty
FX 20 WH 25M	109615	20mm Light Gauge Flexible Conduit White	25m
FX 20 WH 50M	109616	20mm Light Gauge Flexible Conduit White	50m
FX 20 WH 100M	109617	20mm Light Gauge Flexible Conduit White	100m

## Fittings

Light Gauge Flexible Conduit Glands - White & Black



Part No.	A-Code	Description	Pk Qty
H00N20B	109775	20mm Black - IP68	10pcs
H00N25B	109776	25mm Black - IP68	10pcs
H00N32B	109777	32mm Black - IP68	2pcs
H00N50B	109778	50mm Black - IP44	2pcs
CPSGN20W	108716	20mm White - IP68	5pcs

# Contractor Packs

The new Contractor Pack is ideal for everyday installations, with its shrink wrap packing, particularly suitable for storage or confined spaces.

The pack includes a high quality durable 10m Conduit as well as 5 X IP44, or IP68 push fit glands, and is manufactured using standard uPVC.

This next generation cable management solution can be used in conjunction with domestic, commercial and industrial applications.

## Product information

- 20mm and 25mm diameter
- 10m coils
- Black or White
- IP44 push fit glands, Black and White
- P68 glands, screw-fit, Black and White
- Compression resistance
- Impact resistance
- UV stabilised
- IEC61836

## Contractor Packs Black IP44 & IP68



Part No.	A-Code	Description	Pk Qty
CPFX20BIP44	108704	20mm Black pack c/w 5 X IP44 Glands (Push Fit) c/w Locknut	1pc
CPFX25BIP44	108708	25mm Black pack c/w 5 X IP44 Glands Push Fit) c/w Locknut	1pc
CPFX20B IP68	108703	20mm Black pack c/w 5 X IP68 Gland c/w Locknut	1pc
CPFX25B IP68	108707	25mm Black pack c/w 5 X IP68 Gland c/w Locknut	1pc

## Contractor Packs White IP44 & IP68



Part No.	A-Code	Description	Pk Qty
CPFX20WIP44	108706	20mm White pack c/w 5 X IP44 Glands (Push Fit) c/w Locknut	1pc
CPFX25WIP44	108710	25mm White pack c/w 5 X IP44 Glands (Push Fit) c/w Locknut	1pc
CPFX20W IP68	108705	20mm White pack c/w 5 X IP68 Gland c/w Locknut	1pc
CPFX25W IP68	108709	25mm White pack c/w 5 X IP68 Gland c/w Locknut	1pc

## Fittings

### Contractor Packs Glands Black IP44 & IP68



Part No.	A-Code	Description	Pk Qty
CPGN20B	108711	20mm Black IP44 Glands - 5 Pack	1 Bag
CPGN25B	108713	25mm Black IP44 Glands - 5 Pack	1 Bag
CPSGN20B	108715	20mm Black IP68 Glands/Locknuts - 5 Pack	1 Bag
CPSGN25B	108717	25mm Black IP68 Glands/Locknuts - 5 Pack	1 Bag

### Contractor Packs Glands White IP44 & IP68



Part No.	A-Code	Description	Pk Qty
CPGN20W	108712	20mm White IP44 Glands - 5 Pack	1 Bag
CPGN25W	108714	25mm White IP44 Glands - 5 Pack	1 Bag
CPSGN20W	108716	20mm White IP68 Glands/Locknuts - 5 Pack	1 Bag
CPSGN25W	108718	25mm White IP68 Glands/Locknuts - 5 Pack	1 Bag



# Twin Wall Ducting

Univolt's Twin Wall Ducting is available in various diameters, from 40mm-110mm and in 50m coils. Twin Wall Ducting is made from High Density Polyethylene (HDPE), which makes it the ideal product to protect electrical cables buried underground. The Twin Wall Ducting also comes supplied with a Draw-Wire and Built-on Coupler.

The external corrugated profile gives the product added strength whilst the internal bore is smooth to prevent cables snagging.

Certified to EN61386-24 and with a compression resistance of 450N, Univolt's Twin Wall Ducting is compliant to class 3 specification, making it ideal for installations in structural and civil engineering, in concrete and underground.

### Product information

- Diameter 40mm-110mm - 50m Coil
- UV stabilised
- Wall thickness - 4.5mm
- Black (RAL 9005),
- Temp range : -25°C/+60°C
- Relevant Standard: EN 61386-24 including Built-on Coupler and Draw-Wire
- Supporting accessories also available

## Ducting



Part No.	A-Code	Description	Pk Qty
FXKVR 40	55107	40mm Twin Wall Ducting	50m
FXKVR 50	99018	50mm Twin Wall Ducting	50m
FXKVR 63	32332	63mm Twin Wall Ducting	50m
FXKVR 75	26353	75mm Twin Wall Ducting	50m
FXKVR 90	41343	90mm Twin Wall Ducting	50m
FXKVR 110	41344	110mm Twin Wall Ducting	50m



Fittings

Ducting Coupler

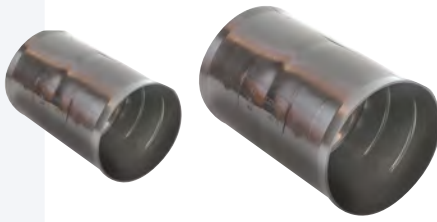

Part No.	A-Code	Description	Pk Qty
FXKVM 40	55202	40mm Underground Ducting Coupler	1pc
FXKVM 50	25755	50mm Underground Ducting Coupler	1pc
FXKVM 63	25756	63mm Underground Ducting Coupler	1pc
FXKVM 75	25757	75mm Underground Ducting Coupler	1pc
FXKVM 90	25758	90mm Underground Ducting Coupler	1pc
FXKVM 110	103649	110mm Underground Ducting Coupler	1pc

Nominal Size	Outer Diameter Da	Tolerance	Inner Diameter Di (minimal)
40	40.0	+0.8/-0.0	32.0
50	50.0	+1.0/-0.0	41.0
63	63.0	+1.2/-0.0	52.0
75	75.0	+1.4/-0.0	62.2
90	90.0	+1.7/-0.0	74.0
110	110.0	+2.0/-0.0	93.0

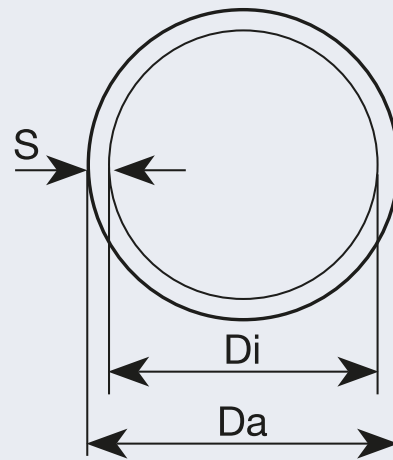



# Enclosure Boxes

## Enclosures, Knockout Boxes White / Black



Part No.	A-Code	Description	Pk Qty
PKG100 W	16402	Enclosure Box 105x105x64mm with knockouts 20mm & 25mm White	5pcs
PKG100B	16404	Enclosure Box 105x105x64mm with knockouts 20mm & 25mm Black	5pcs
PKG200W	12344	Enclosure Box 200x150x85mm with knockouts 20mm to 32mm White	2pcs
PKG200B	10789	Enclosure Box 200x150x85mm with knockouts 20mm to 32mm Black	2pcs

## Enclosures, Plain Sided White / Black



Part No.	A-Code	Description	Pk Qty
PKG100OPW	850	Enclosure Box 105x105x64mm Plain Sides White	5pcs
PKG100OPB	848	Enclosure Box 105x105x64mm Plain Sides Black	5pcs
PKG200OPW	11629	Enclosure Box 200x150x85mm Plain Sides White	2pcs
PKG200OPB	10790	Enclosure Box 200x150x85mm Plain Sides Black	2pcs
PKG300OPW	13006	Enclosure Box 300x200x125mm Plain Sides & Hinged Lid White	1pcs
PKG300OPB	13010	Enclosure Box 300x200x125mm Plain Sides & Hinged Lid Black	1pcs

# Accessories

Draw Tape



Part No.	A-Code	Description	Pk Qty
UNIDT 10	85861	10m Nylon Draw Tape	1pc
UNIDT 20	85862	20m Nylon Draw Tape	1pc
UNIDT 30	85863	30m Nylon Draw Tape	1pc

Cutting Tool



Part No.	A-Code	Description	Pk Qty
USZ-S	15008	Cutting Tool for Conduits up to 32mm and Trunking up to 25x40mm	1pc



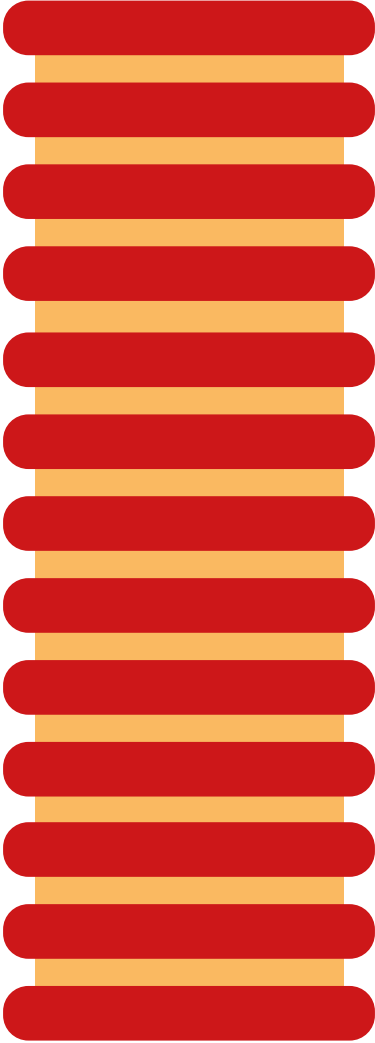
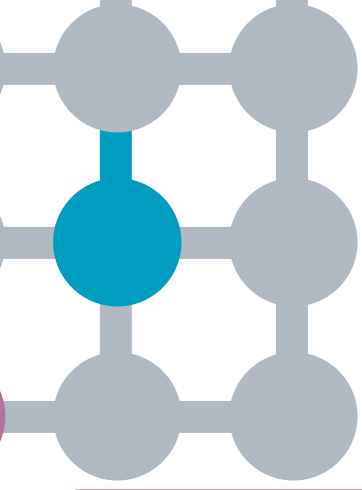

Phone: 01707 379820  
sales@dietzel-univolt.com  
www.univolt.co.uk

Unit 2  
A1 Connect  
Cole Green Lane  
Welwyn Garden City  
AL7 4FW



In pursuance of our policy of product development Univolt UK Ltd. reserve the right to change the design or specification of its products without notification. E & OE.